



PumpTech Customer Education



<http://www.Pumptechnw.com>

Bellevue

Moses Lake

Canby

PumpTech Product Lines

UL Listed
Packaged Systems

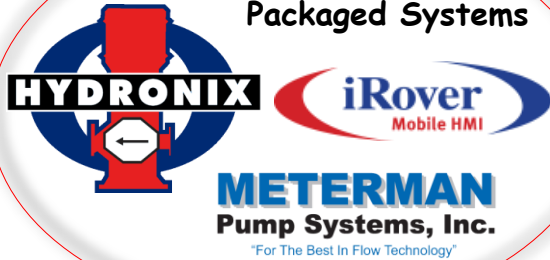



Two full time Mechanical Engineers
Licensed in OR, WA & ID

SolidWorks & E-Drawings Viewer

AutoCad Compatible Drawings

All Systems UL QCZJ Listed

Designed to HI Standards





Manufacturing Facility Canby, OR





Installation, Maintenance & Repair

- 9 Full Time Service Technicians
- 3 Full Service Shops
- 6 Service Trucks
- 23 Ton Crane Truck
- 8 Ton Crane Truck
- 3 Ton Crane Truck
- 2 Ton Flatbed & Trailer
- 1 Ton Flatbed & Trailer





Pipeline

Summer 2010 www.PumpTechnw.com Volume 1, Issue 2

PumpTech Inc.
Bellevue, WA
12020 SE 32nd St #2
Bellevue, WA 98005
888-644-6888

Canby, OR
321 S Sequoia Parkway
Canby, OR 97103
503-659-6230

Moscow Lake, WA
209 S Hamilton Rd
Moscow Lake WA 98637
509-786-6330

PumpTech Pipeline
Serving the Pacific Northwest
Providing Knowledgeable Solutions

Cornell Names PumpTech Its Top Industrial Distributor

Cornell Pump Company (Clackamas, Oregon) has named PumpTech its number one industrial pump distributor in the US. Cornell pump manufacturers a wide line of clear water, solids handling, hot oil and food processing pumps for numerous industrial applications.

Mike Shoemaker, PumpTech's Industrial Products Manager, accepted the award at the annual distributor's meeting in Chicago. Our industrial sales team covers Idaho.

Oregon and Washington and focuses on the food processing, petrochemical, oil & gas, lumber, pulp & paper, power generation, and aluminum industries.

In addition to Cornell, PumpTech represents a number of other manufacturers of specialty industrial products. Congratulations to our industrial sales team!



PumpTech Named NW Master Distributor for Grundfos

Grundfos Pumps (Olathe, Kansas) has selected PumpTech as the Pacific Northwest master distributor for its Grundfos Dosing line of chemical metering pumps.

The product line includes a wide range of diaphragm metering pumps with flows to 1050 GPH and with flows to 3000 PSI. Grundfos pressures offer a variety of dosing technologies including digital dosing. Digital dosing pumps utilize stepper-motors that allow a 1000:1

turn down. In addition to dosing pumps, Grundfos offers a complete line of measurement & disinfection equipment including one of the best chlorine generators on the market.

Per this agreement PumpTech will stock \$100,000 of Grundfos Dosing pumps to support sales in the Pacific Northwest. This inventory will be centrally located in our Canby, OR branch and will allow quick delivery to other distributors, end users, and OEM's. Additionally, this inventory will support our MeterMan division which manufactures chemical metering systems in our Canby facility and also functions as the Grundfos Key Systems provider for the entire western United States.



Inside this issue:

- WA State Parks
- Astoria Energy
- Ammonia Skids
- Oil Sands Skids
- Maintenance
- Pump Ed (I)
- Moscow Lake
- PumpTech
- Teams
- Info
- Upcoming

Fall 2010 www.PumpTechnw.com Volume 1, Issue 3

PumpTech Inc.
Bellevue, WA
12020 SE 32nd St #2
Bellevue, WA 98005
888-644-6888

Canby, OR
321 S Sequoia Parkway
Canby, OR 97103
503-659-6230

Moscow Lake, WA
209 S Hamilton Rd
Moscow Lake WA 98637
509-786-6330

PumpTech Pipeline
Serving the Pacific Northwest
Providing Knowledgeable Solutions

PumpTech's Feature Rich Multi-Pump Controller

PumpTech's intelligent, multi-pump controller features an integrated PLC and Color Touch-Screen Human Machine Interface (HMI) that makes setup simple and extremely flexible. Up to four pumps can be set up for VFD control, across the line starting or a combination of the two.

The PLC provides for 22 digital inputs and 12 digital outputs. Also two 4-20mA or 0-10VDC transducer inputs are provided.

The controller is preprogrammed for pump down, level control and booster applications. At start up all you have to do is select the application and follow the setup instructions on the screen.

When motors are started across the line or via RVSS, "smart" motor

Continued on Page 4



QCEC Introduces New Refrigerated Sampler

Quality Control Equipment Company (QCEC) has introduced a new sampler with a modular refrigeration system. The refrigerator unit slides out for easy service or replacement. All units are made right here in the US and come with a 2 year warranty.

It features the same, time proven sampling technology that has set QCEC apart from its competition for over 40 years. All samplers use vacuum pumps

rather than peristaltic pumps for higher reliability and accuracy. Vacuum pumps never need hose replacement and increase the sampling range by providing lifts to 28 feet and horizontal of flexibility when locating the sampling unit.

The QLS model is the only sampler in the world that provides repeatable, self calibration and consistent sample size. It also provides flow - paced samples from a 4 - 20 input.

For more information on the features and benefits of QCEC samplers, contact your local PumpTech branch.



Inside this issue:

- Knights Bridge Rd 421 2
- Spanway Selcaprom 3
- Newport Booster 3
- PumpTech Controller 4
- Maintenance Tips 4
- Pump Ed (II) 5
- Chapparraville 6
- PumpTech PumpChat 7
- WEFTEC 2010 7
- Information & Credits 8
- Upcoming Events 8

newsletter@PumpTechnw.com



Pump Ed 101

Joe Evans, Ph.D

<http://www.PumpEd101.com>

<http://www.PumpTechnw.com>

Branch Line Pumping Options

Branch Lines - Closed or Open Loop

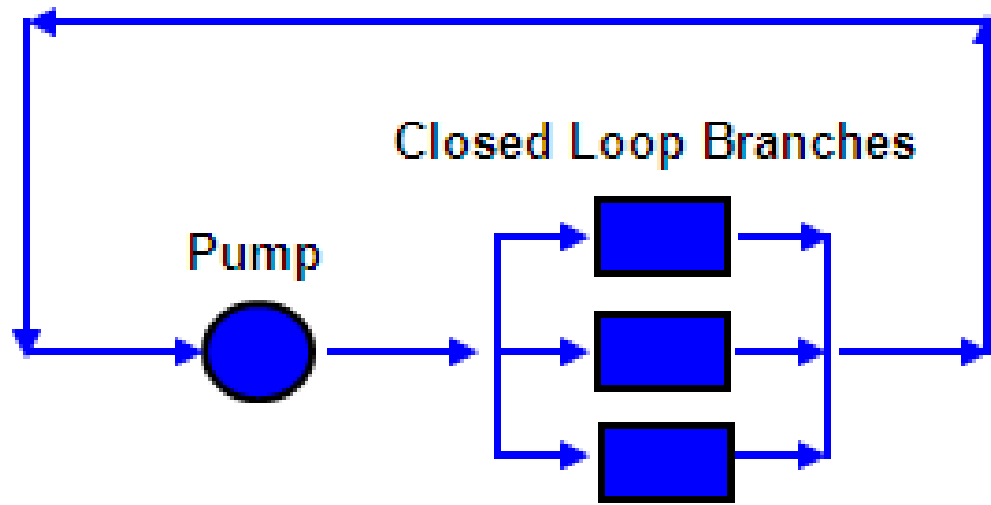

$$HP = \text{Flow} \times \text{Head} / 3960 \times \text{eff}$$

Branch Lines - Open Discharge

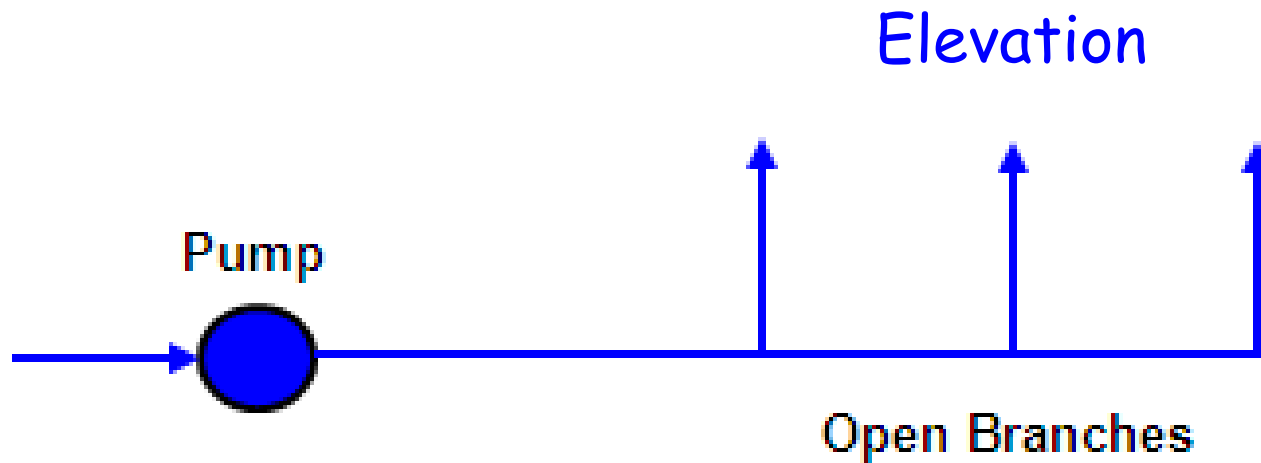

$$HP = \text{Flow} \times \text{Head} / 3960 \times \text{eff}$$

Branch Lines - Open Discharge

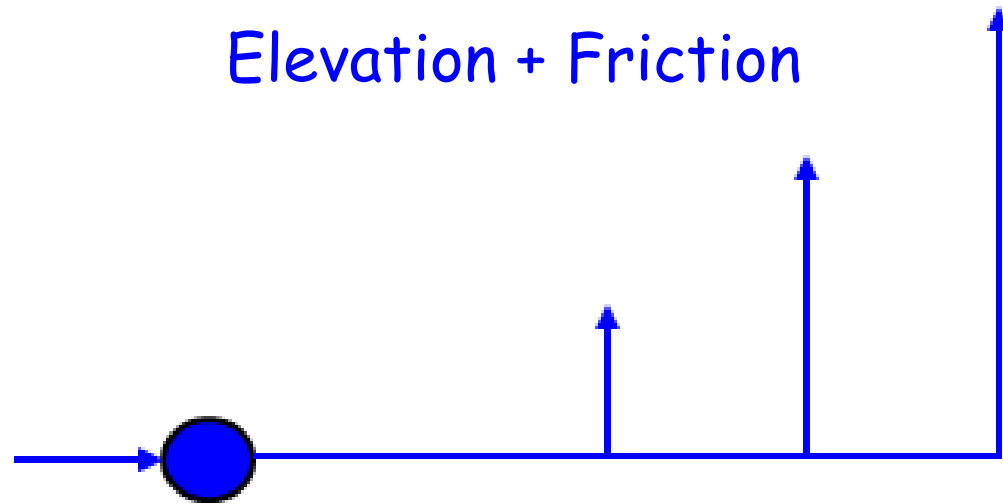

$$HP = \text{Flow} \times \text{Head} / 3960 \times \text{eff}$$

Branch Lines - Open Discharge

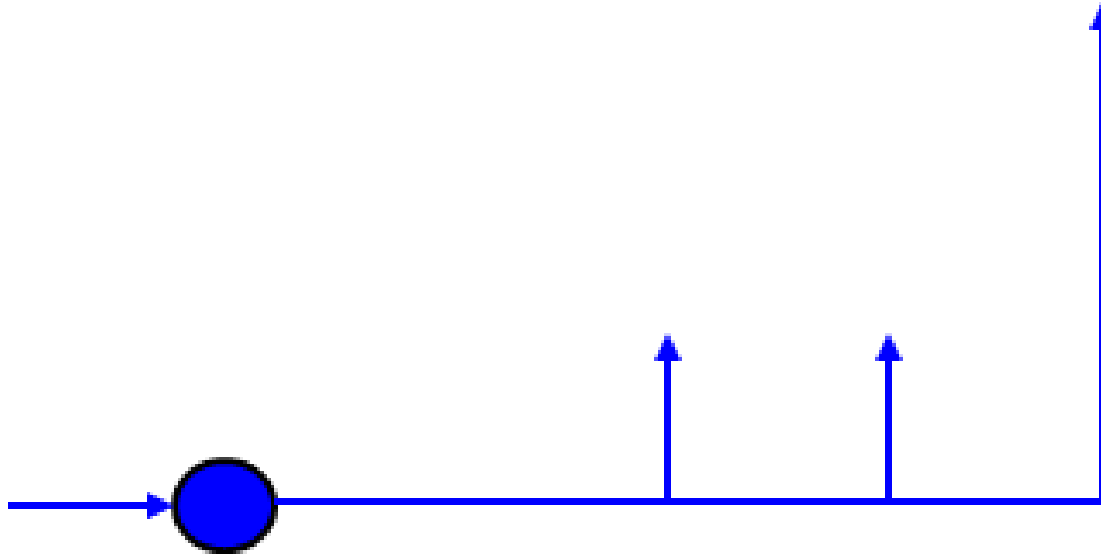

$$HP = \text{Flow} \times \text{Head} / 3960 \times \text{eff}$$

Branch Lines - Open Discharge

Flow = 1000 gpm Head = 50'

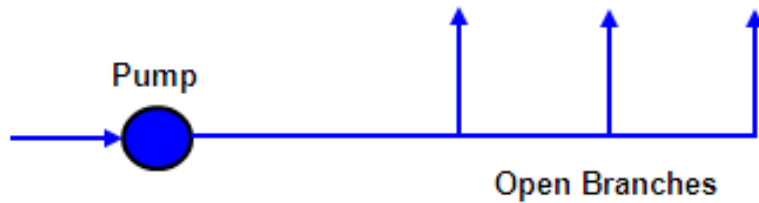

HP = 15.5

Flow = 1000 gpm Head = 150'

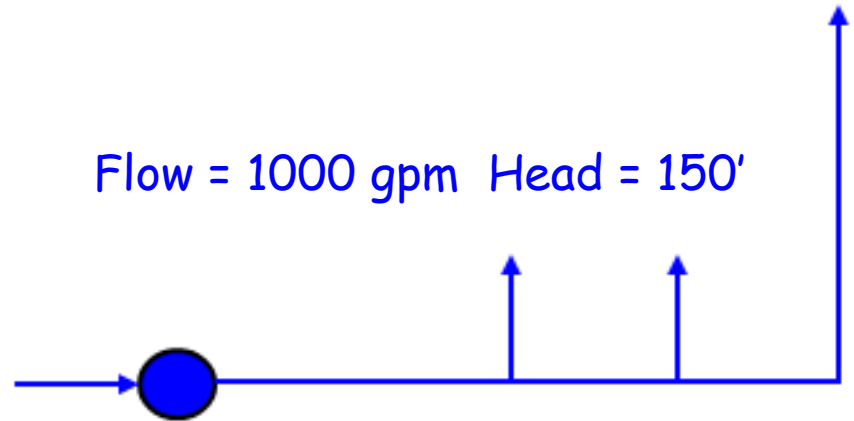

HP = 46.5

At 666 gpm HP = 30.9

$$\text{HP} = \text{Flow} \times \text{Head} / 3960 \times \text{eff}$$

Branch Line Options

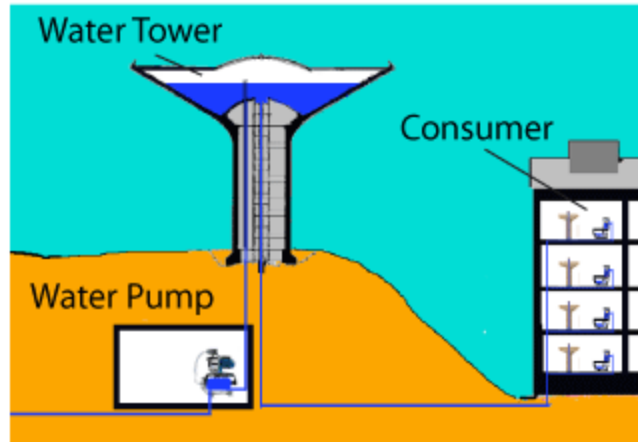
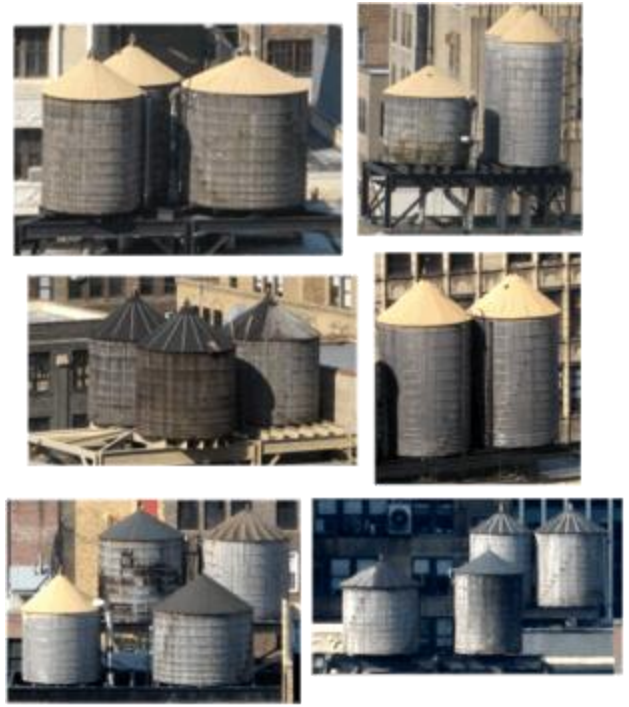

Branch Line Options

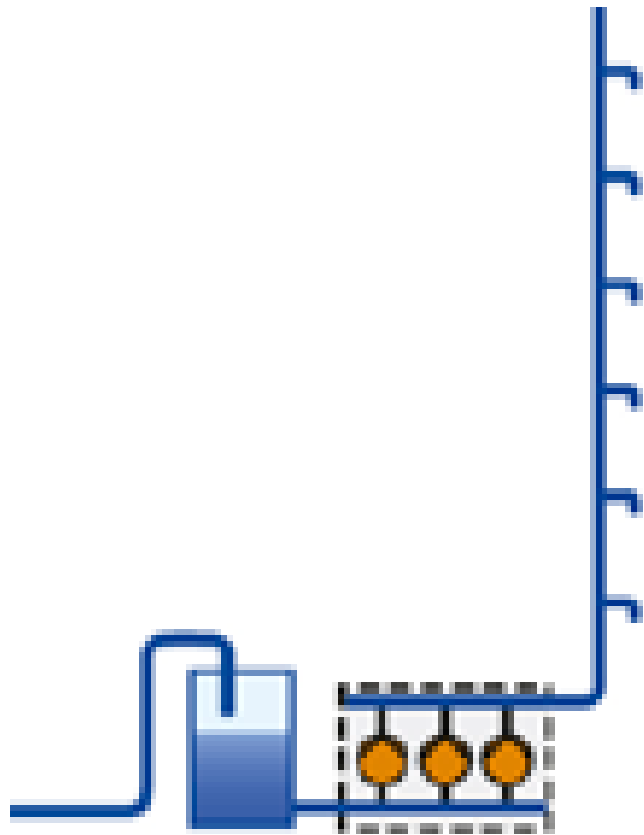

Branch Line Options

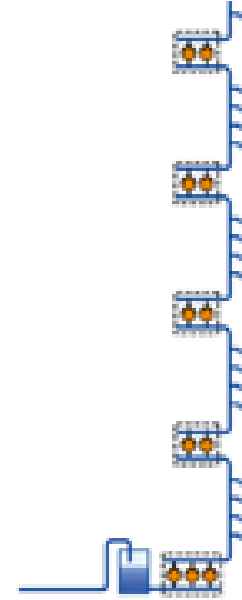
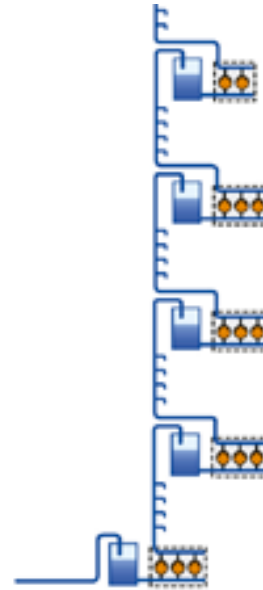
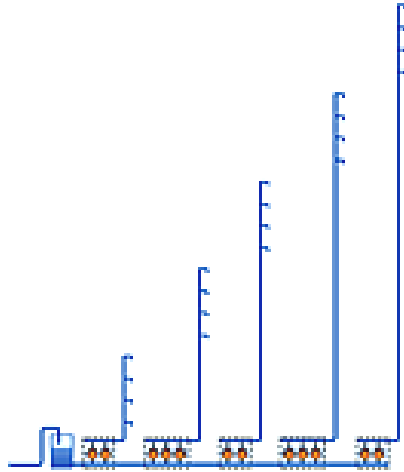
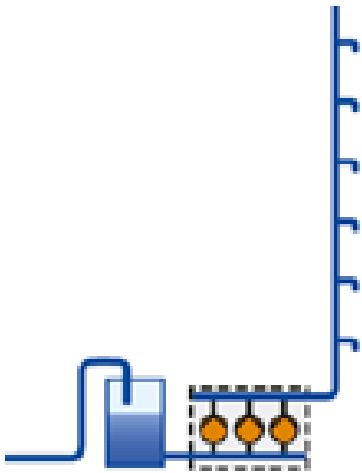

Single Pump - Single Pipeline

Branch Line Pumping

Multiple Discharges / Single Pump & Pipeline
versus
Multiple Pumps / Multiple Pipelines

$$HP = (\text{Flow} \times \text{Head}) / (3960 \times \text{Efficiency})$$

One Pump / One Pipeline

Point A to B & C

$$43.2 \text{ HP} = (600 \times 200) / (3960 \times 0.7)$$

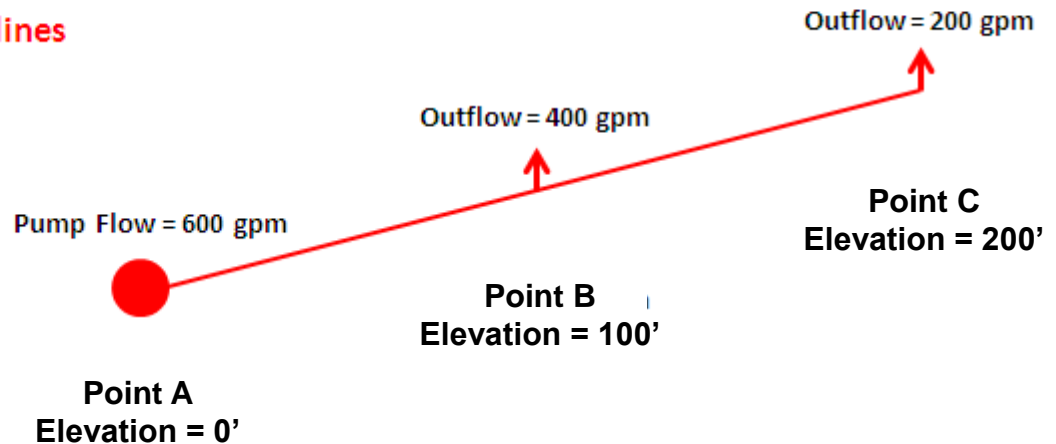

Multiple Pumps - Multiple Pipelines

Branch Line Pumping

Multiple Discharges / Single Pump & Pipeline versus Multiple Pumps / Multiple Pipelines

$$HP = (\text{Flow} \times \text{Head}) / (3960 \times \text{Efficiency})$$

One Pump / One Pipeline

Point A to B & C

$$43.2 \text{ HP} = (600 \times 200) / (3960 \times 0.7)$$

Two Pumps / Two Pipelines

Point A to B

$$14.4 \text{ HP} = (400 \times 100) / (3960 \times 0.7)$$

Point A to C

$$14.4 \text{ HP} = (200 \times 200) / (3960 \times 0.7)$$

Head includes elevation & friction but the example assumes zero friction. Other assumptions include 70% pump efficiency and valves at points B & C.

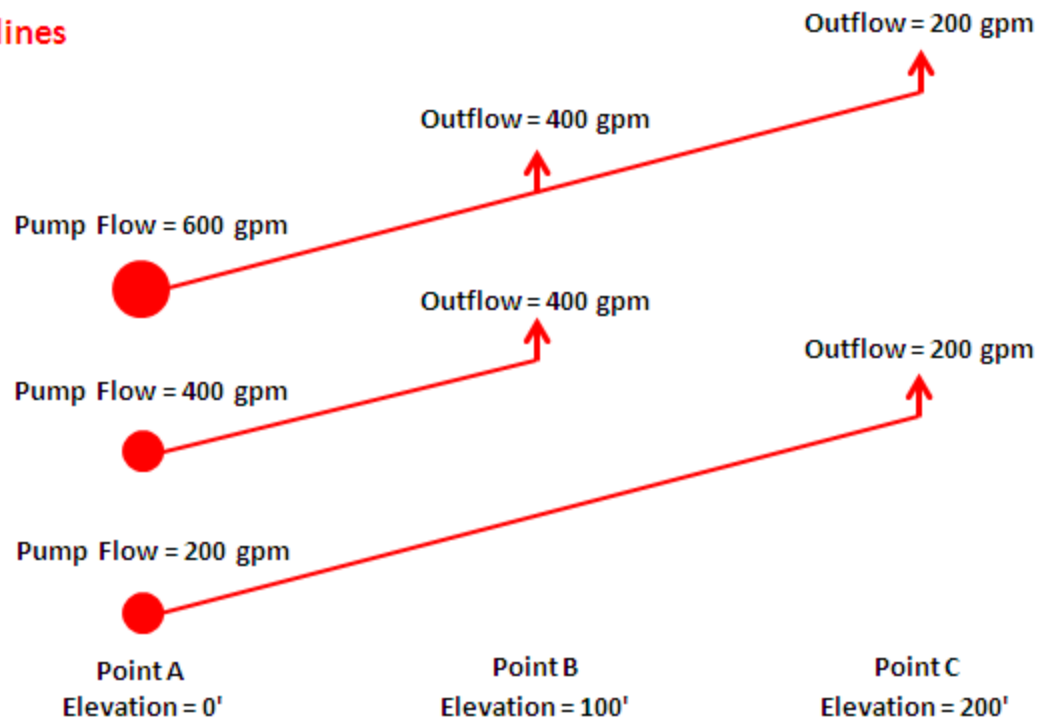

Branch Line versus Multiple Line Analysis

REQUIRED DATA	A to B & C	A to B	A to C	? to ?
Pump Operation - Hours / Day	8	8	8	0
Pump Operation - Days / Year	365	365	365	0
Pump Flow - GPM	600	400	200	0
Pump Head - Feet	200	100	200	0
Pump Efficiency - %	70%	70%	70%	70%
Motor Efficiency - %	94.0%	90.0%	90.0%	90.0%
Energy Cost in \$/KWH	\$0.11	\$0.11	\$0.11	\$0.00
Initial & Additional System Costs	\$44,000.00	-10,000.00 *	17,000.00 *	
RESULTS				
Annual Flow	105,120,000	70,080,000	35,040,000	0
BHP At Design Point	43.3	14.4	14.4	0.0
Wire to Water Efficiency - %	66%	63%	63%	63%
Annual Energy Cost	\$11,035.06	\$3,841.83	\$3,841.83	\$0.00
KW Per 1000 Gallons Pumped	0.954	0.498	0.997	#DIV/0!
Cost Per 1000 Gallons Pumped	\$0.105	\$0.055	\$0.110	#DIV/0!
PAYBACK				
Annual Savings - \$\$	\$3,351.39			
Annual Savings - %	30%			
Additional cost	\$7,000			
Payback - Years	2.1			

Single Pump - Single Pipeline

Branch Line Pumping

Multiple Discharges / Single Pump & Pipeline
versus
Multiple Pumps / Single Pipeline

$$HP = (\text{Flow} \times \text{Head}) / (3960 \times \text{Efficiency})$$

One Pump / One Pipeline

Point A to B & C

$$43.2 \text{ HP} = (600 \times 200) / (3960 \times 0.7)$$

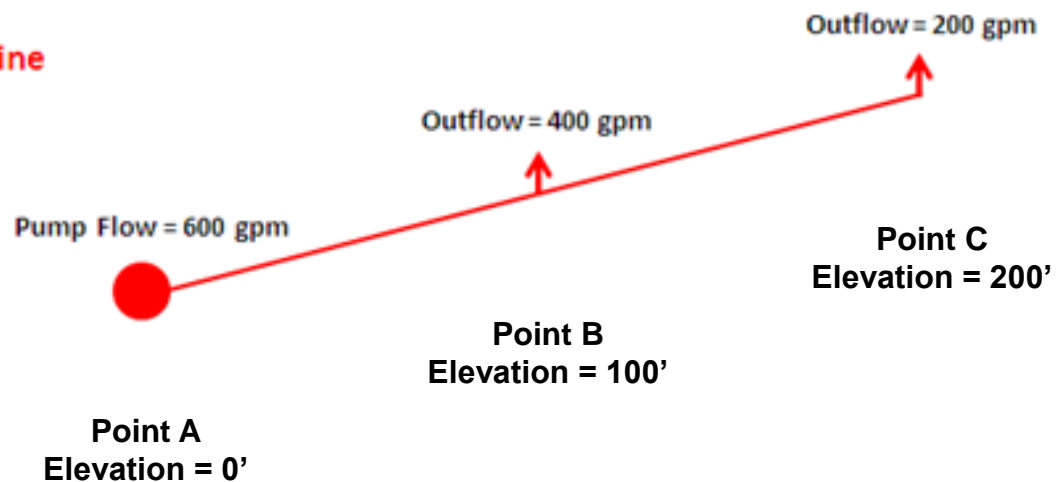

Multiple Pumps- Single Pipeline

Branch Line Pumping

Multiple Discharges / Single Pump & Pipeline
versus
Multiple Pumps / Single Pipeline

$$HP = (\text{Flow} \times \text{Head}) / (3960 \times \text{Efficiency})$$

One Pump / One Pipeline

Point A to B & C

$$43.2 \text{ HP} = (600 \times 200) / (3960 \times 0.7)$$

Two Pumps / One Pipeline

Point A to B

$$21.6 \text{ HP} = (600 \times 100) / (3960 \times 0.7)$$

Point B to C

$$7.2 \text{ HP} = (200 \times 100) / (3960 \times 0.7)$$

Head includes elevation & friction but the example assumes zero friction. Other assumptions include 70% pump efficiency and valves at points B & C.

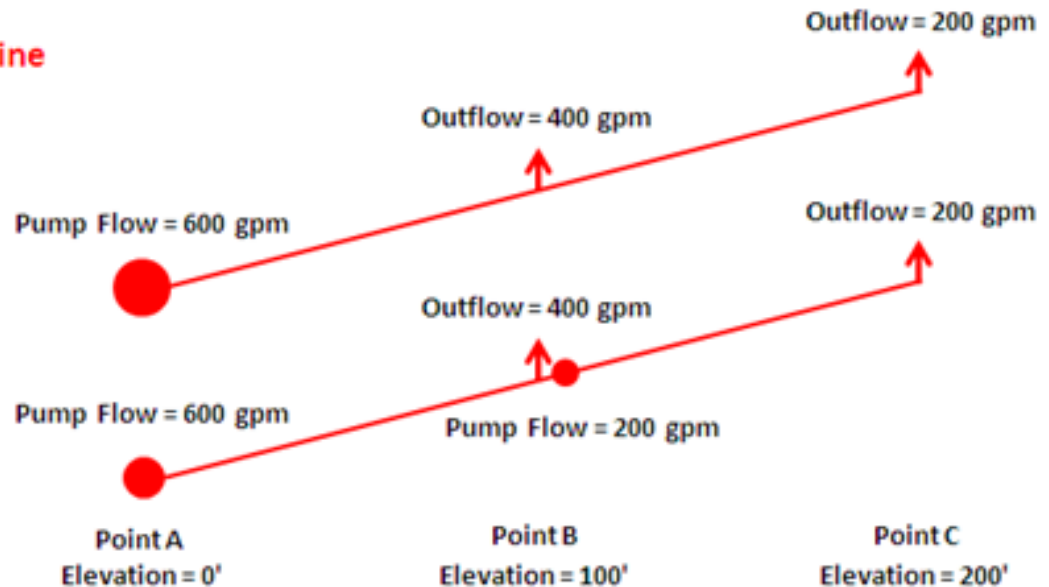

Branch Line versus Multiple Pump Single Line Analysis

REQUIRED DATA

	A to B & C	A to B	B to C	? to ?
Pump Operation - Hours / Day	8	8	8	0
Pump Operation - Days / Year	365	365	365	0
Pump Flow - GPM	600	600	200	0
Pump Head - Feet	200	100	100	0
Pump Efficiency - %	70%	70%	70%	70%
Motor Efficiency - %	94.0%	90.0%	90.0%	90.0%
Energy Cost in \$/KWH	\$0.11	\$0.11	\$0.11	\$0.00
Initial & Additional System Costs	\$44,000.00	-8,000.00 *	11,000.00 *	

RESULTS

Annual Flow	105,120,000	105,120,000	35,040,000	0
BHP At Design Point	43.3	21.6	7.2	0.0
Wire to Water Efficiency - %	66%	63%	63%	63%
Annual Energy Cost	\$11,035.06	\$5,762.75	\$1,920.92	\$0.00
KW Per 1000 Gallons Pumped	0.954	0.498	0.498	#DIV/0!
Cost Per 1000 Gallons Pumped	\$0.105	\$0.055	\$0.055	#DIV/0!

PAYBACK

Annual Savings - \$\$	\$3,351.39
Annual Savings - %	30%
Additional cost	\$3,000
Payback - Years	0.9

Regardless of the Design

Motor & Pump Efficiency

The Performance Curve

- Efficiency
- BEP
- BOP

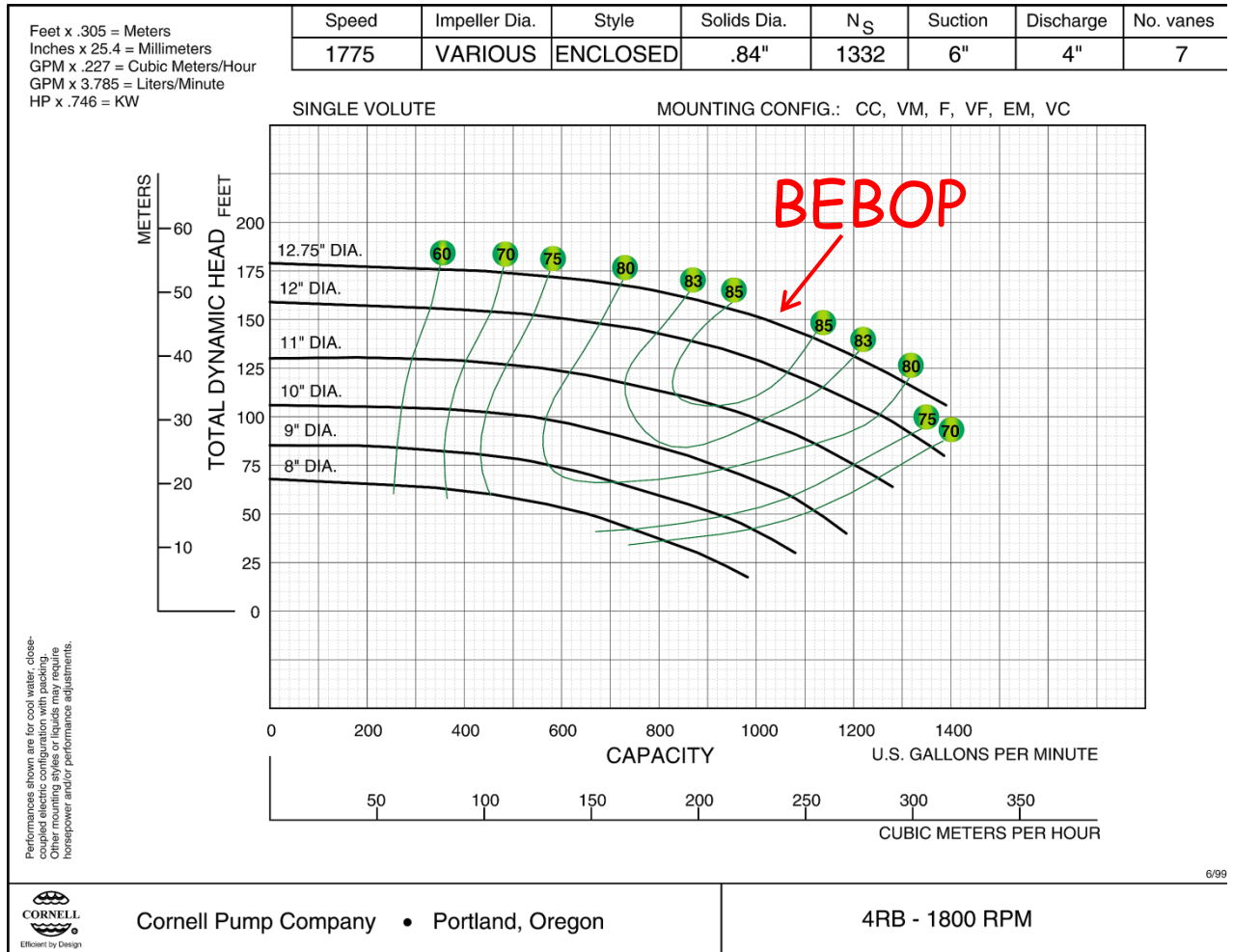

Motor Efficiency

Figure 2: Motor Construction Each Motor is 10 HP, 1200 RPM

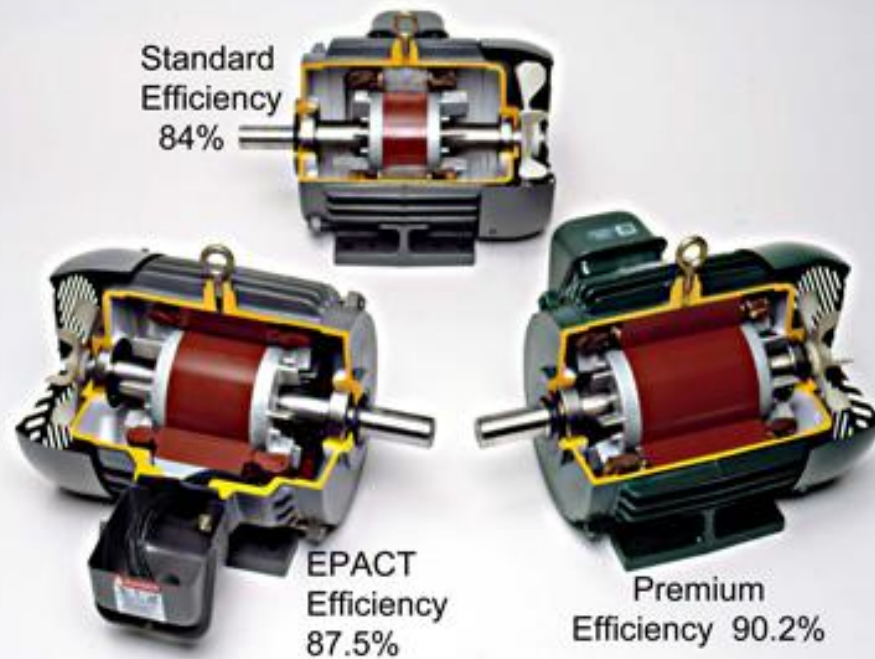

Motor Efficiency versus Load

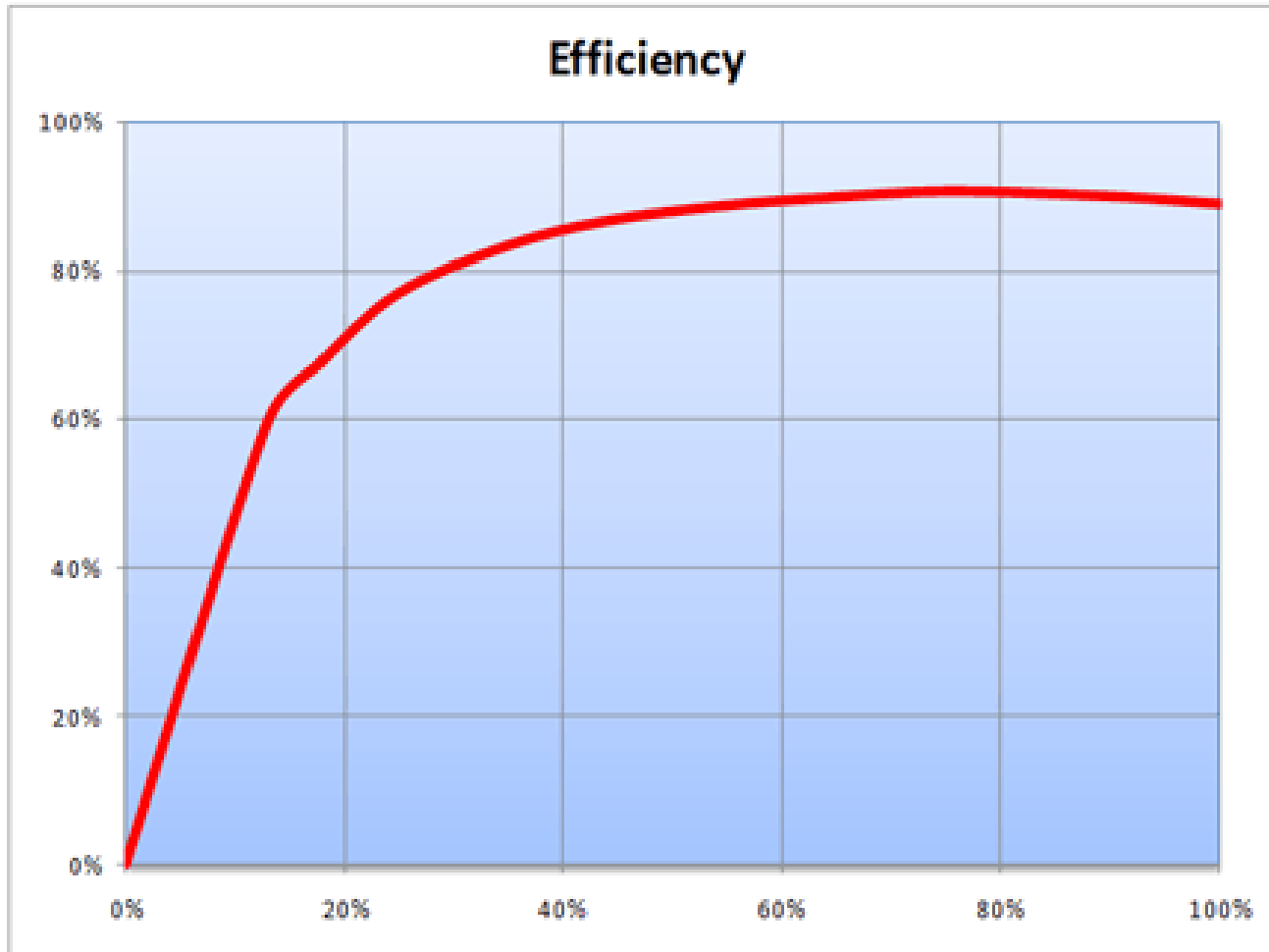

Motor & Pump Efficiency

Motor Efficiency = Mechanical Power / Electrical Power

Pump Efficiency = Fluid Power / Mechanical Power

Total Efficiency = Pump Efficiency X Motor Efficiency

Motor & Pump Efficiency

Total Efficiency = Pump Efficiency X Motor Efficiency

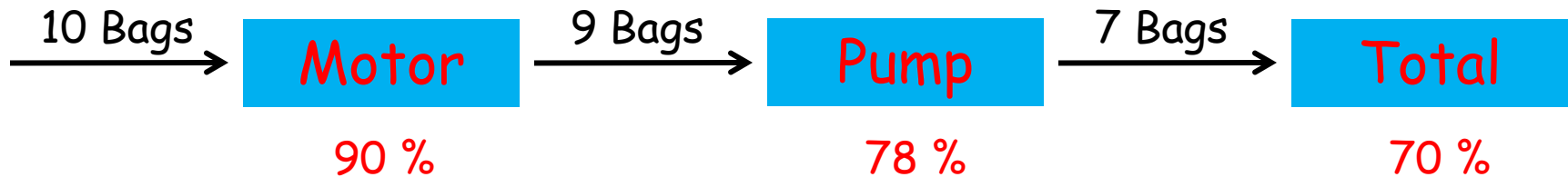

$$0.90 \times 0.78 = 0.70 = 70\%$$

Pump ED 101

Joe Evans, Ph.D

<http://www.PumpEd101.com>

<http://www.Pump-Zone.com>

Branch Line Pumping Options