

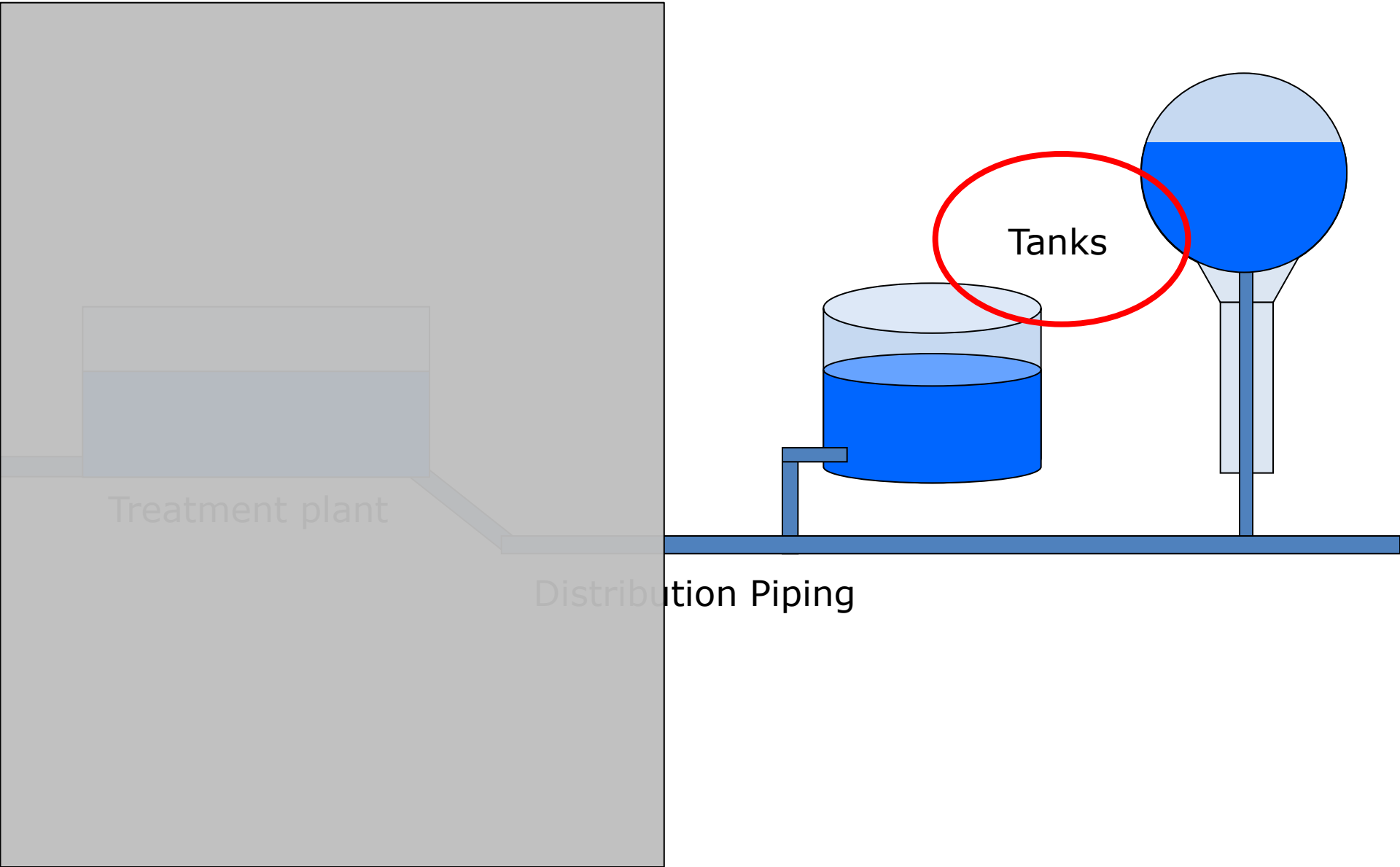

# **Welcome to the 21<sup>st</sup> Century Distribution System**

**Onno Koelman**  
**BSME, Stanford University**

# Focus on Tanks



*Welcome to the 21st century  
treatment site*

*Maintain  
(Boost)  
(Improve)*



# Three New Technologies for Managing the Distribution System

Mixing

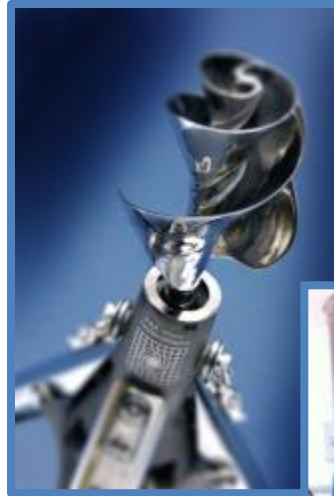

RCS

Reservoir Control System



TRS

THM Removal System

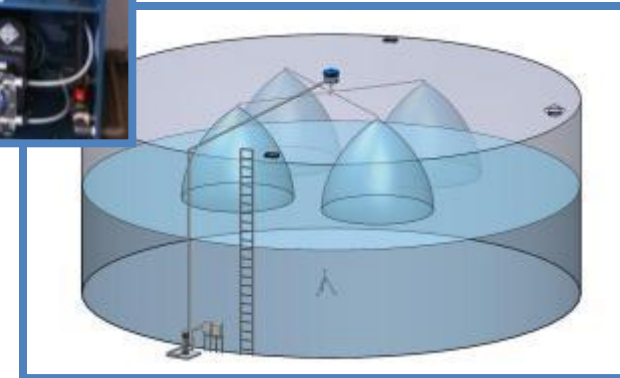

# Audience – Who are you?



Cl en Pwt

# Three New Technologies for Managing the Distribution System

Mixing

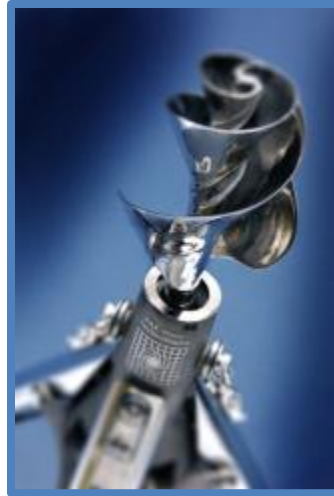

RCS

Reservoir Control System



TRS

THM Removal System

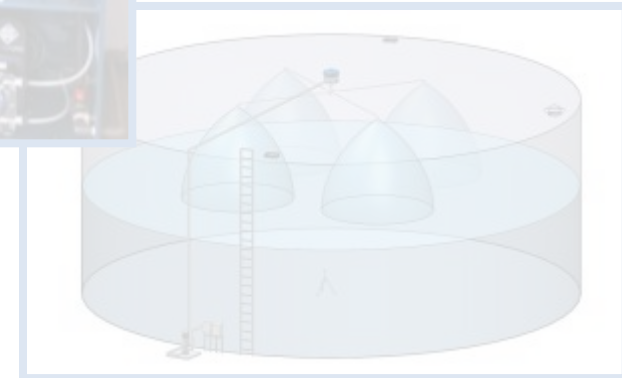



# EPA's Stage II looks for hotspots

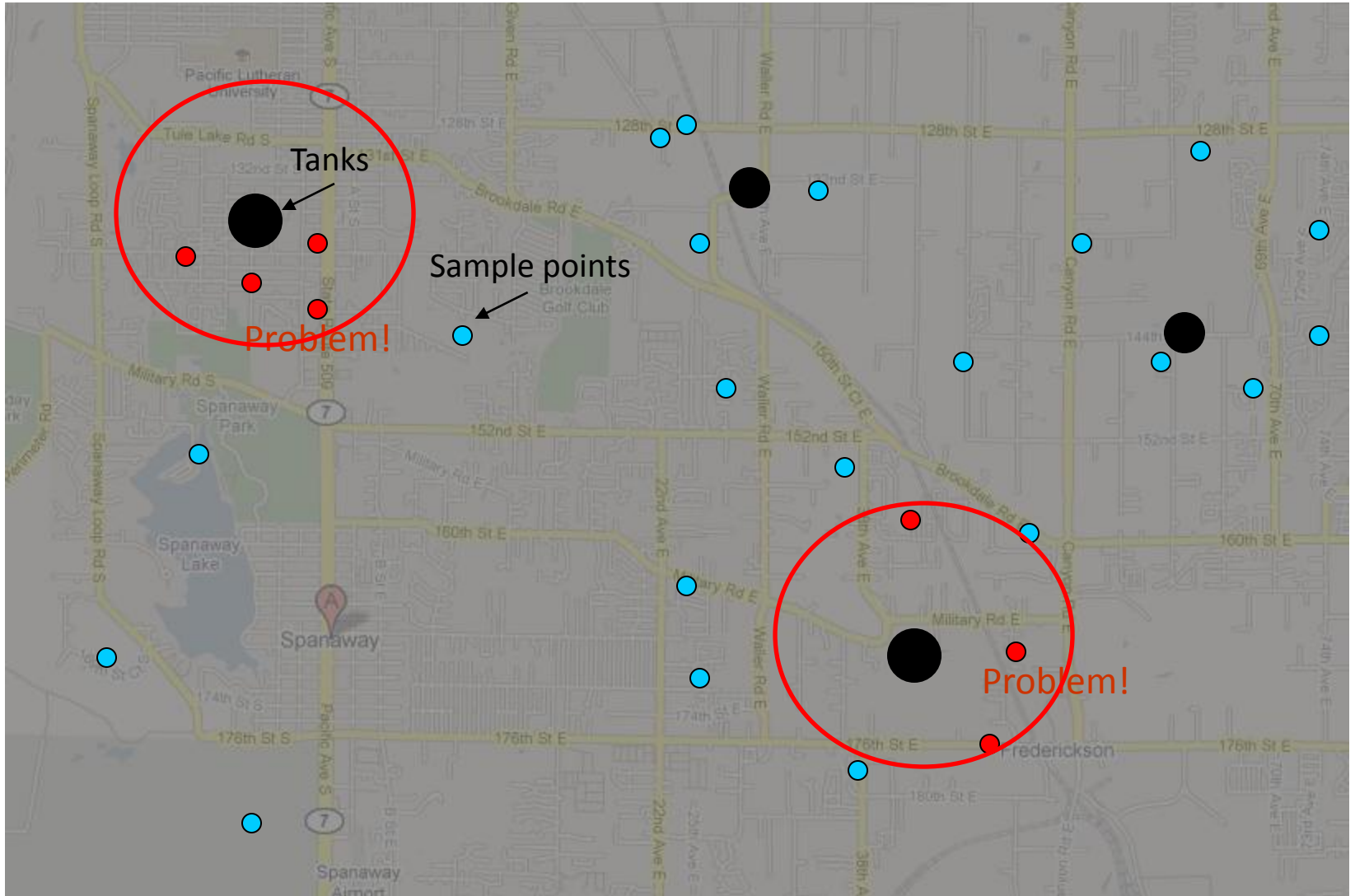

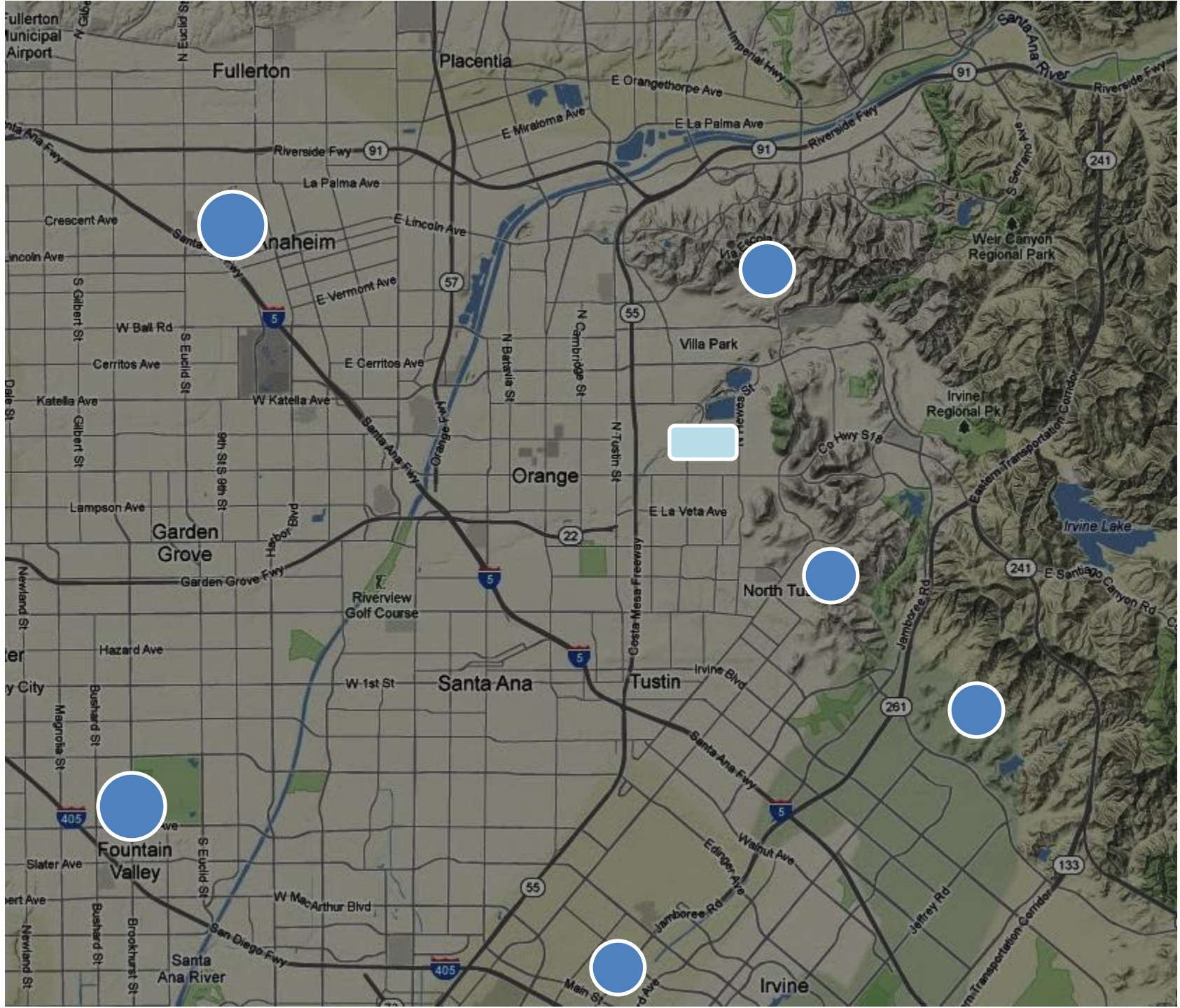



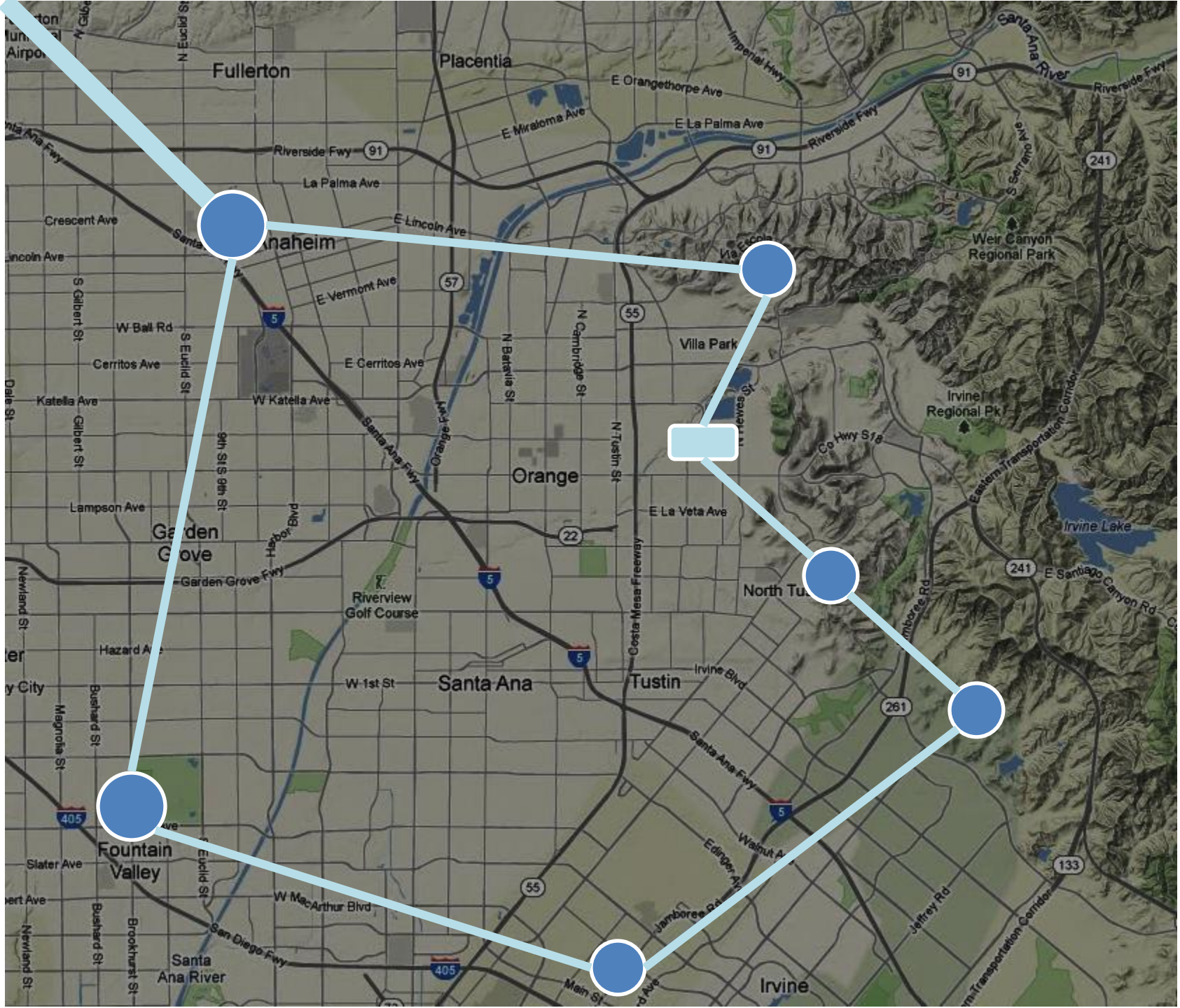



Tanks might store 50% of your water.

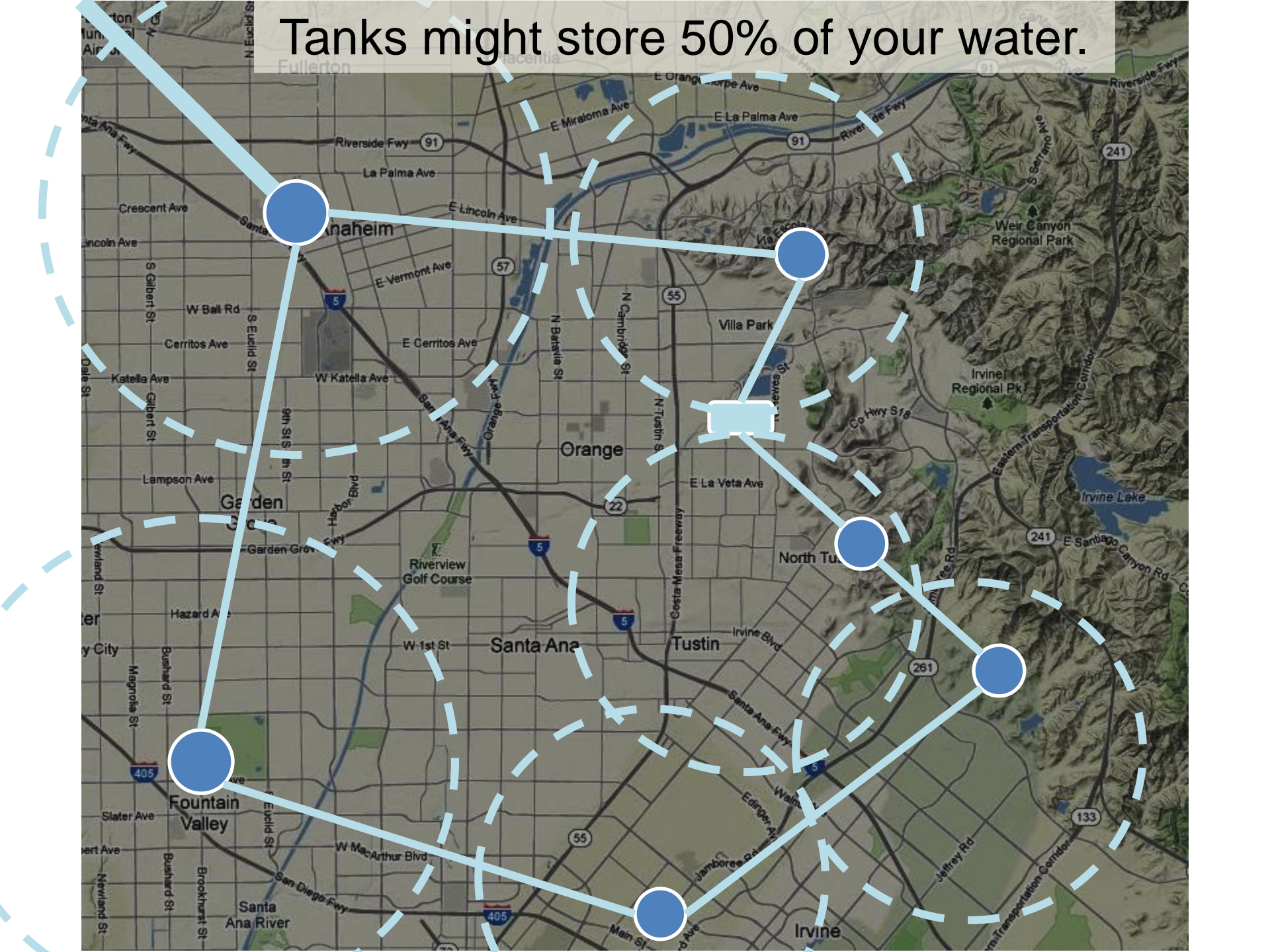



Tanks might store 50% of your water.

Problem: They're vulnerable ...

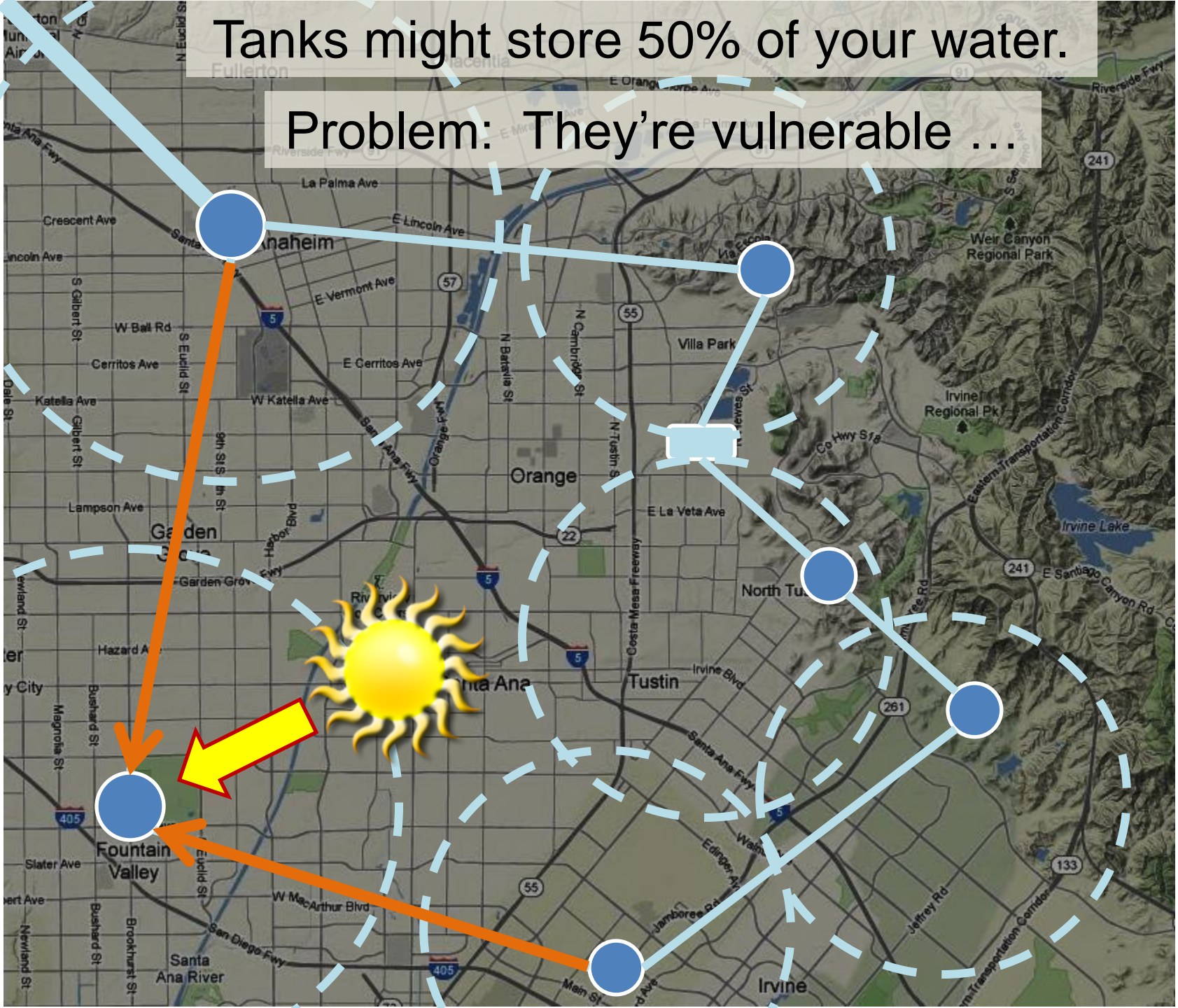



Tanks might store 50% of your water.

Problem: They're vulnerable ...

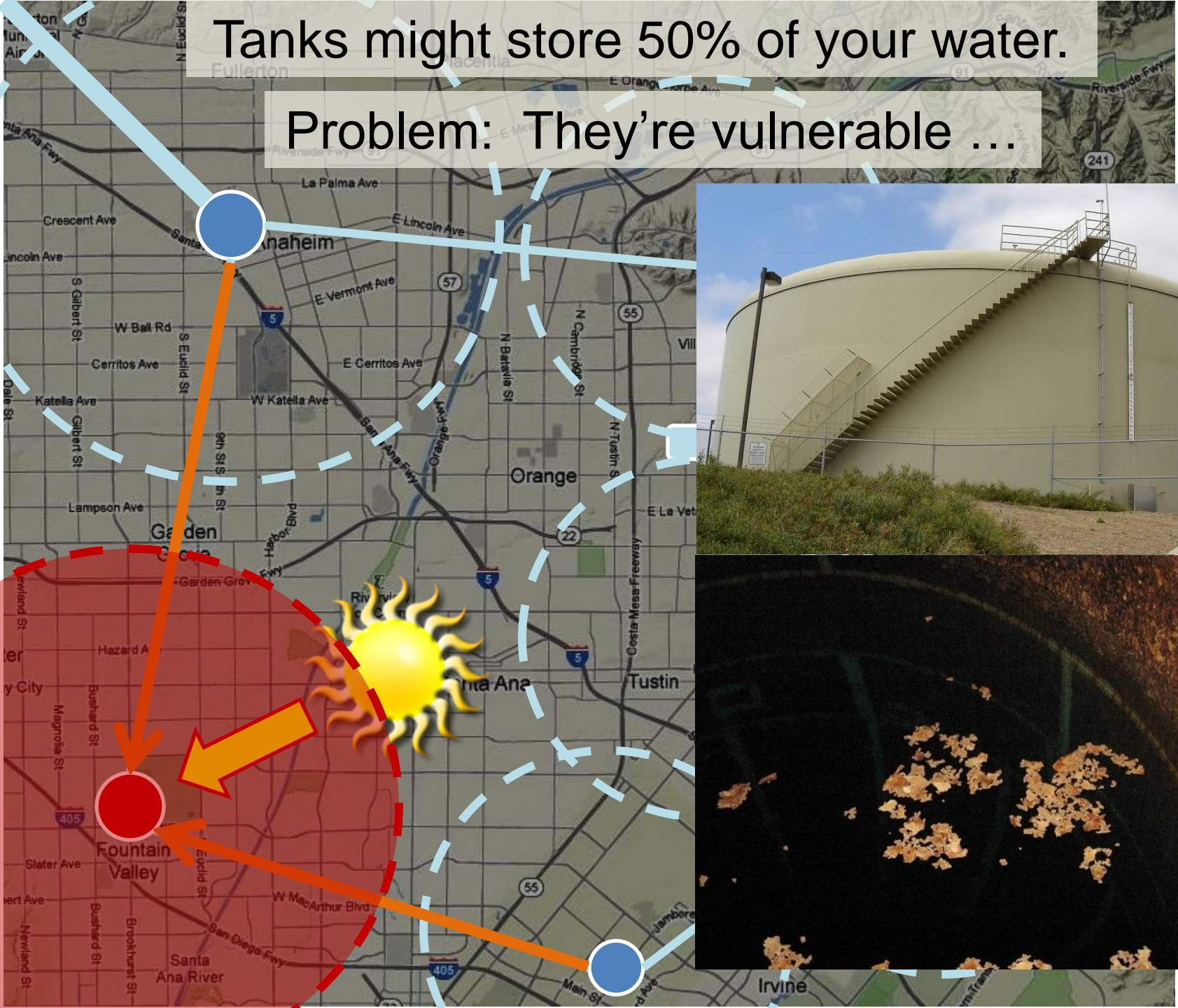







# 3 Problems with Tanks

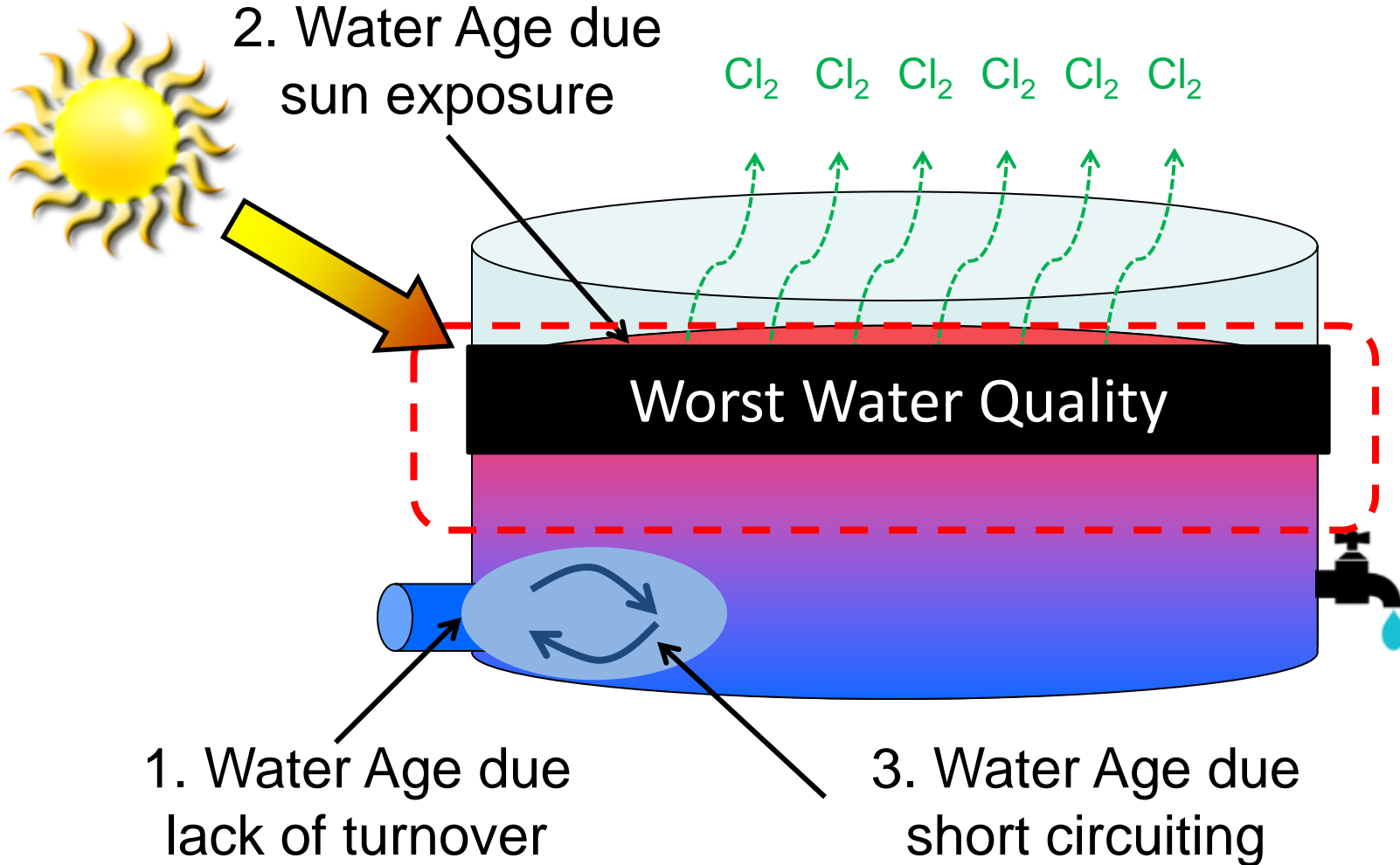

# 1. Low Turnover & Hydraulic Dead Zones

*Tanks are usually OVER-SIZED during design*

- Future build-out needs
- Hard to expand later
- 30% sized for fire flow
- Seasonal demands change

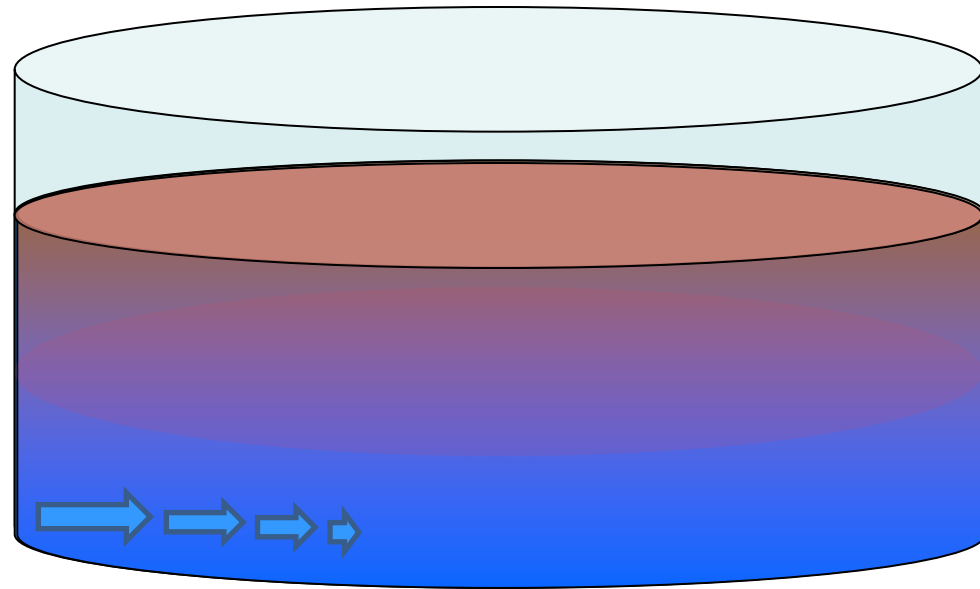



## 2. Persistent Thermal Stratification

Many tanks...

- have common inlet/outlets
- are exposed to **sunlight**
- fill with **cold** water

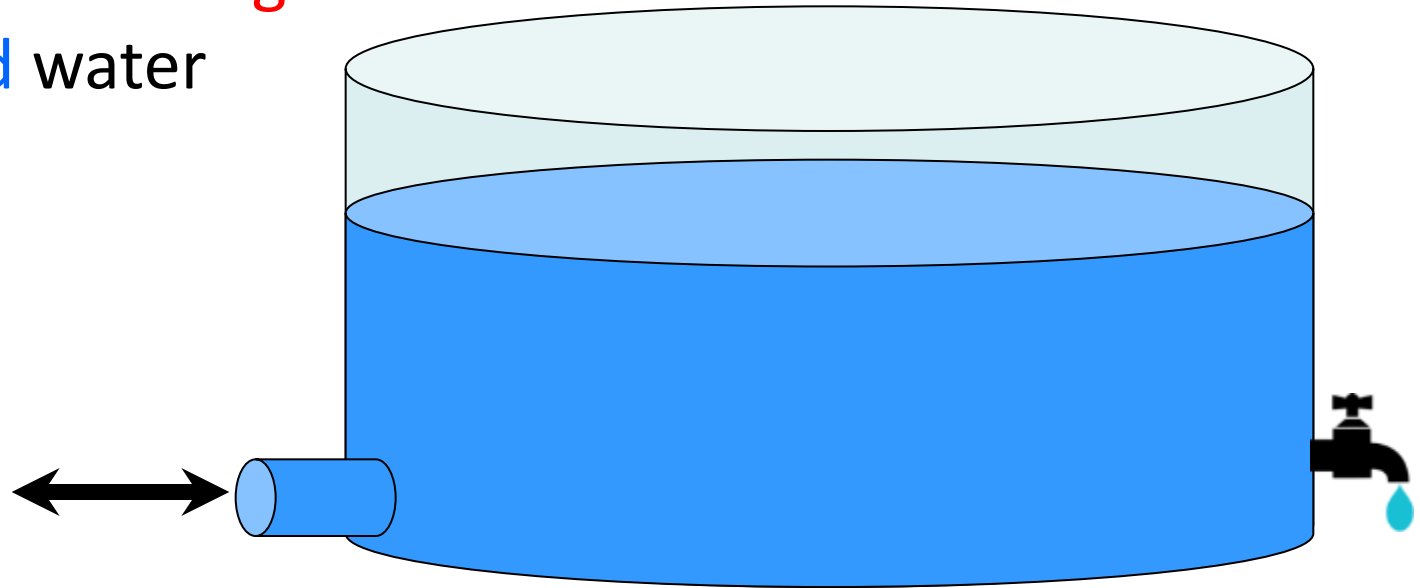

# How does stratification happen?

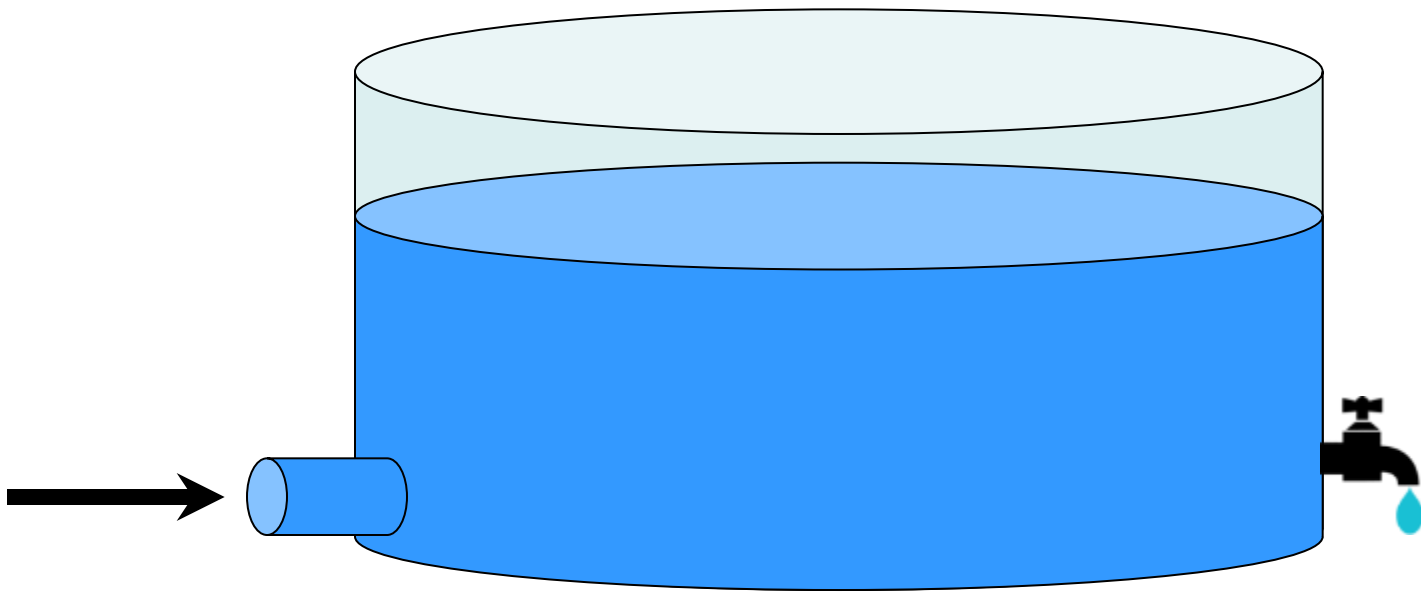

Tank fills ...

# How does stratification happen?

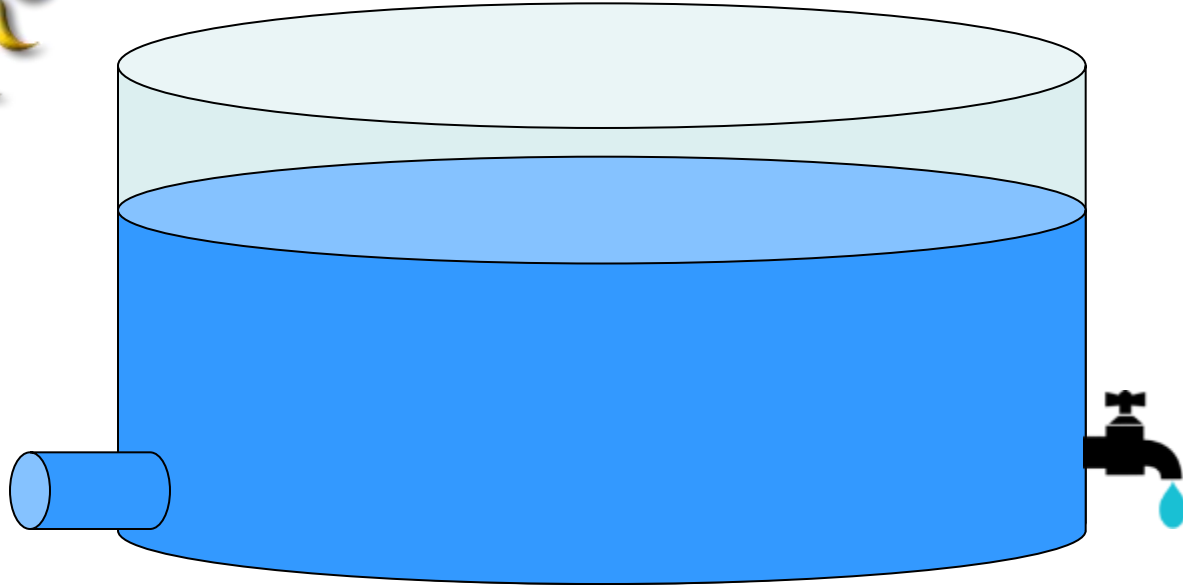

Sun warms tank ...

# How does stratification happen?

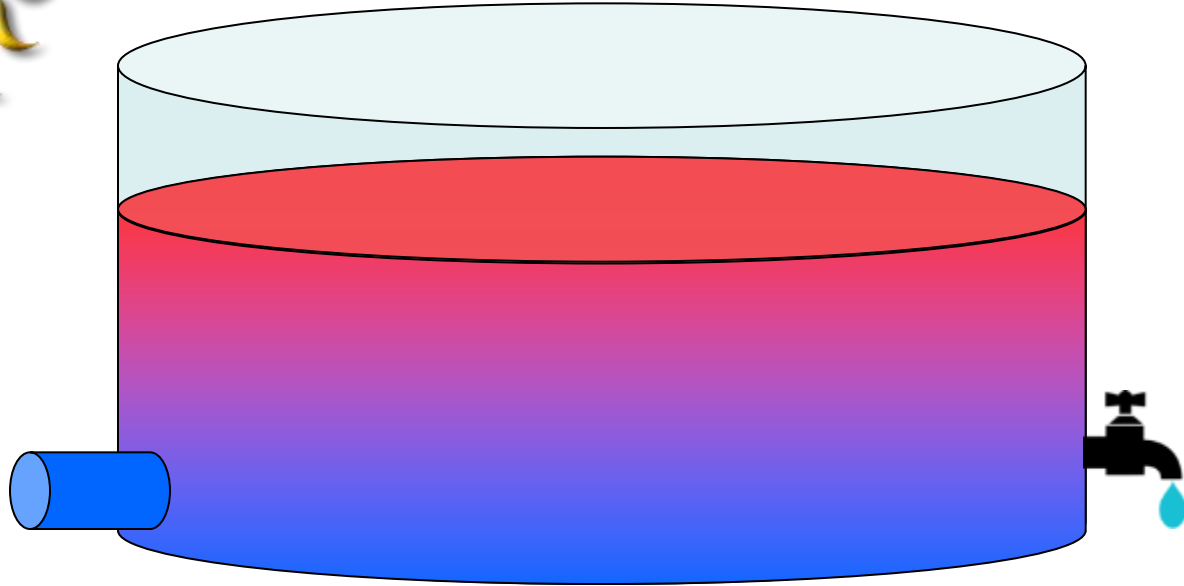

Hot water rises ...



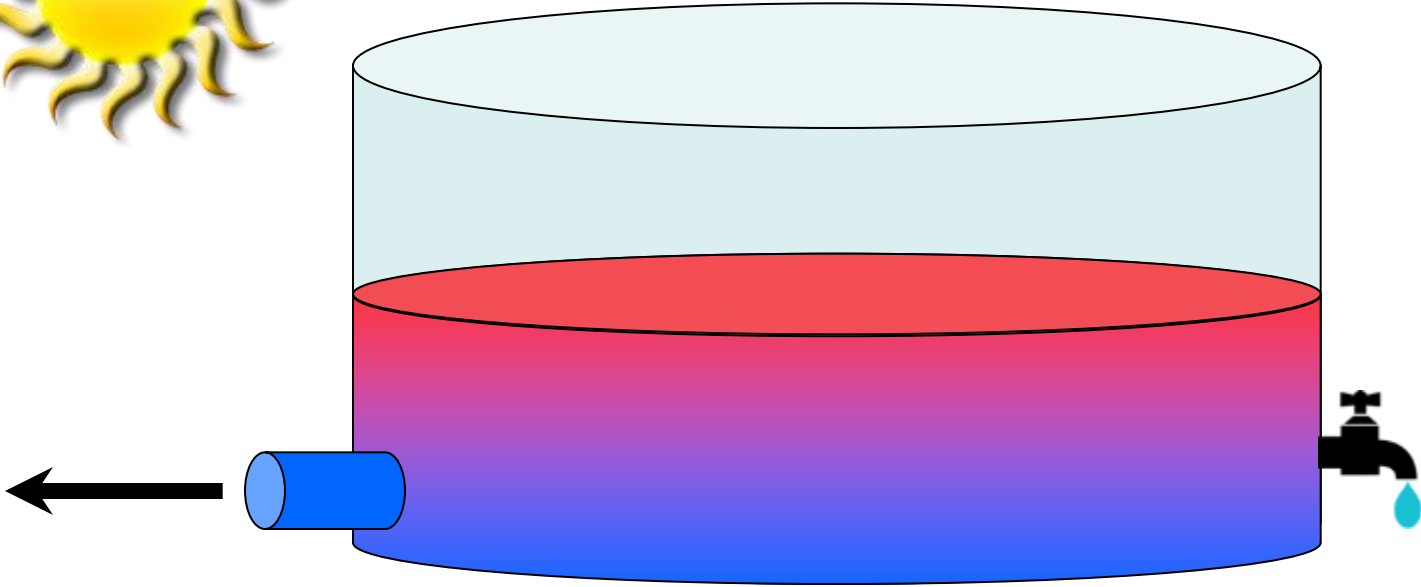

Cool water drains out ...

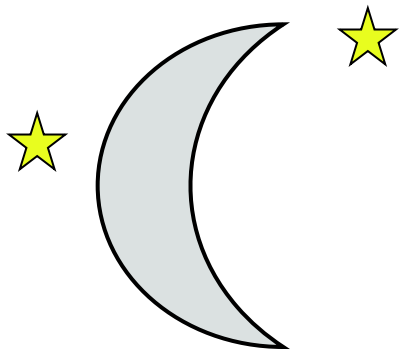

Strong and persistent thermocline established

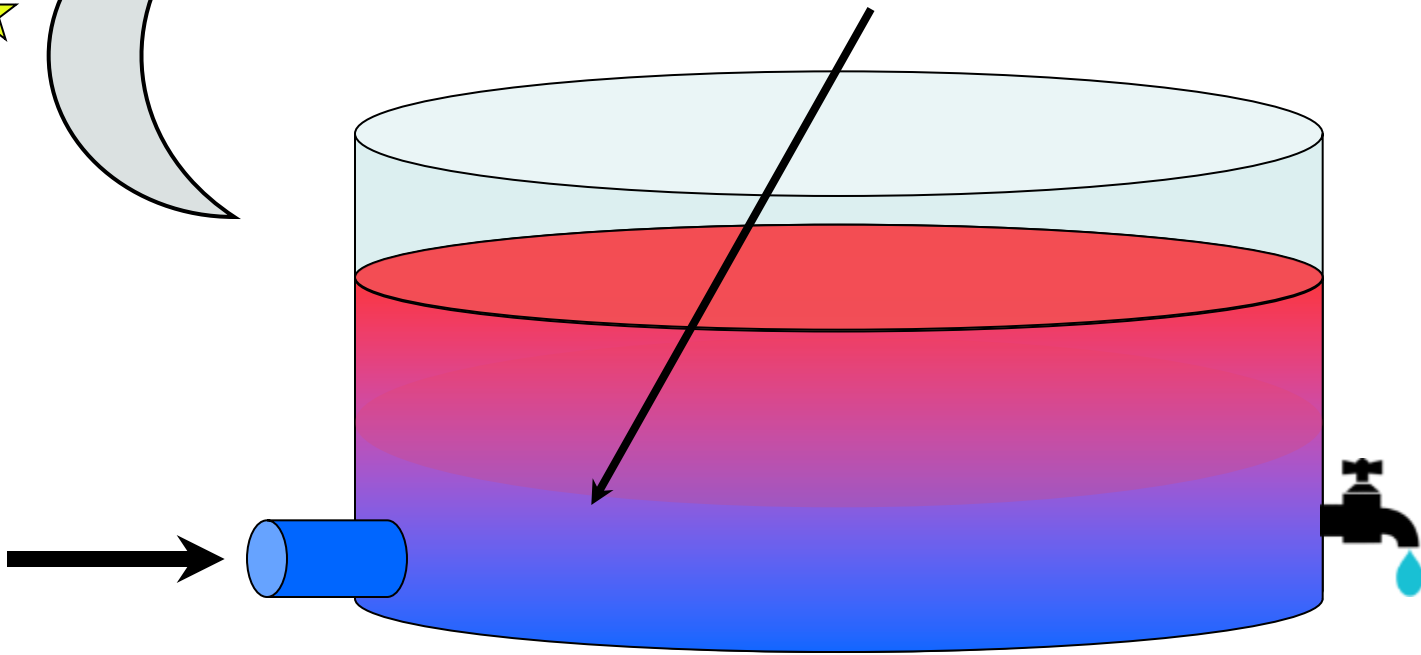

Cool water fills tank ...

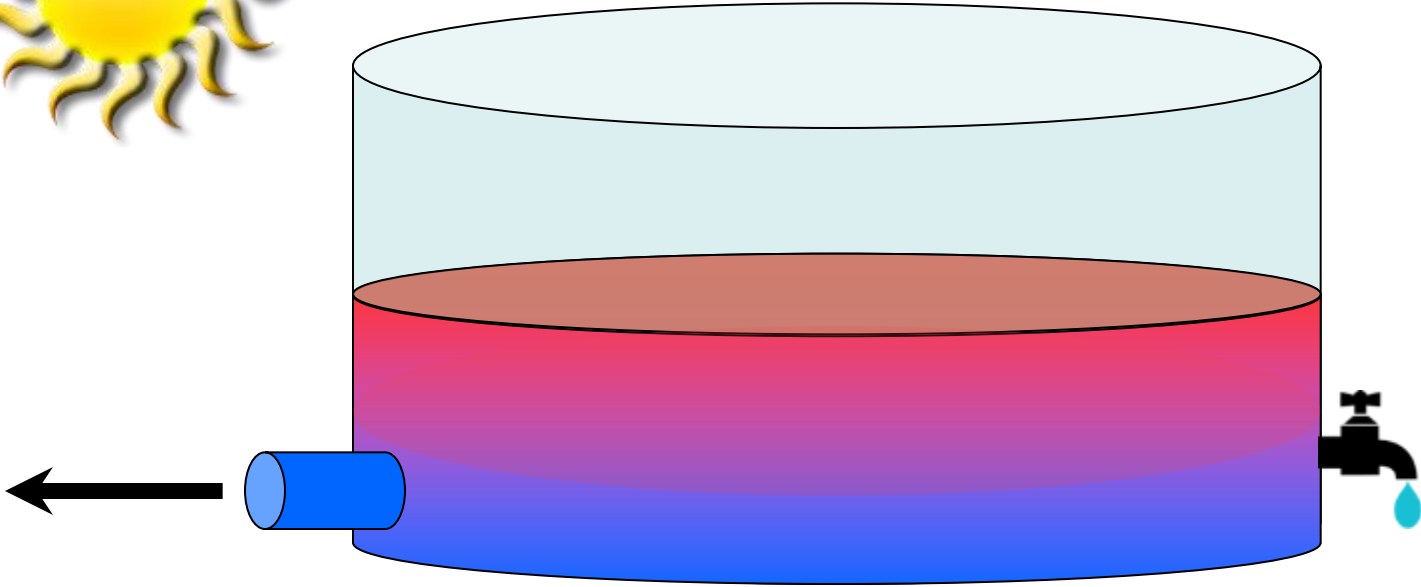

Cool water drains out ... again.  
Top water is now getting older

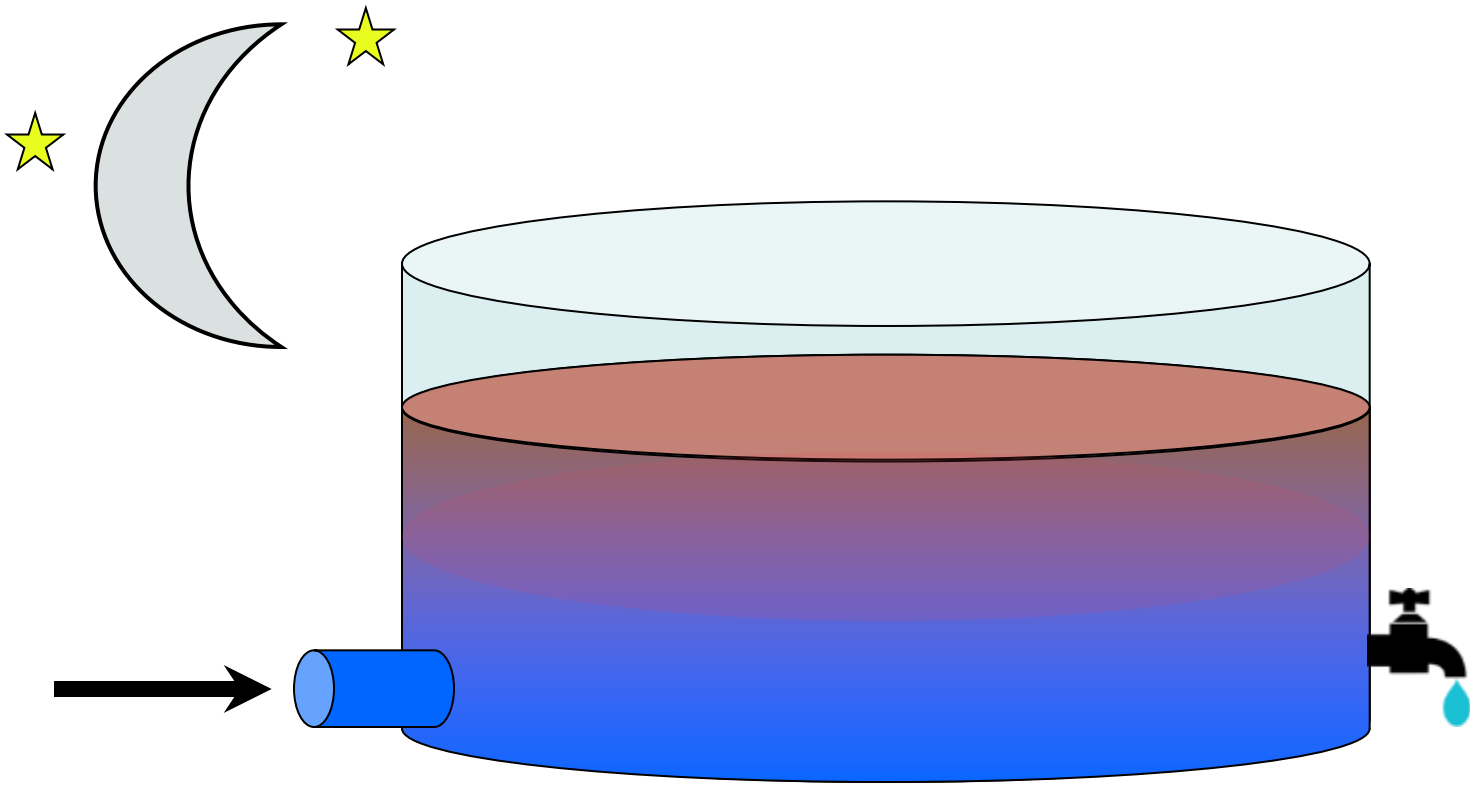

Cool water fills at night ... again  
Top layer floats like a piston, still not mixed



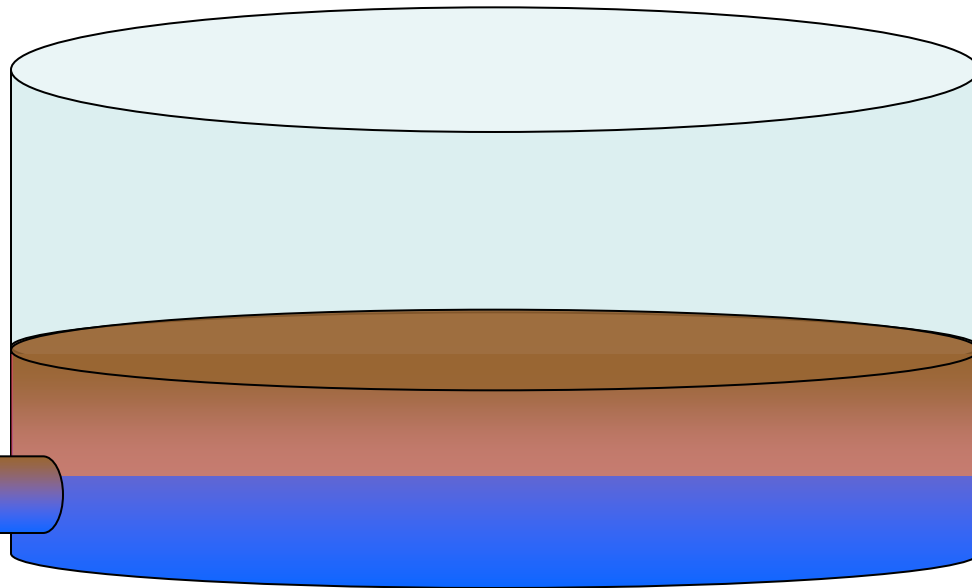

?@ \$#!!



Customer Complaints

Bad sample

One day, too much demand  
Deep cycling may not fully disrupt this thermal layer  
→ Customer complaints, biofilm, etc

# Deep cycling is NOT a mixing solution...

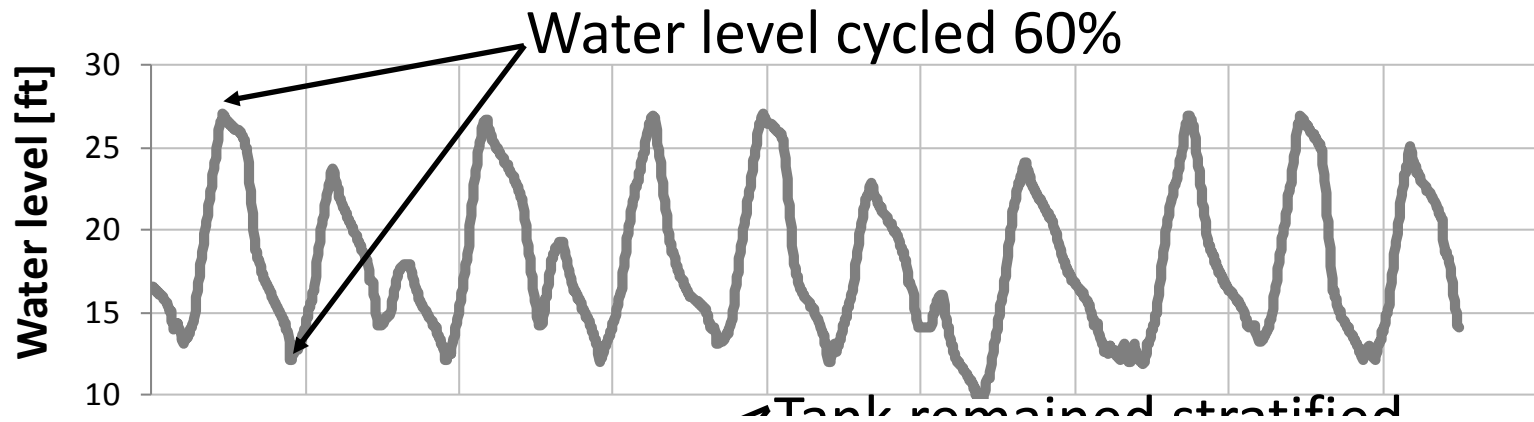

# Beware Seasonal "Inversions"

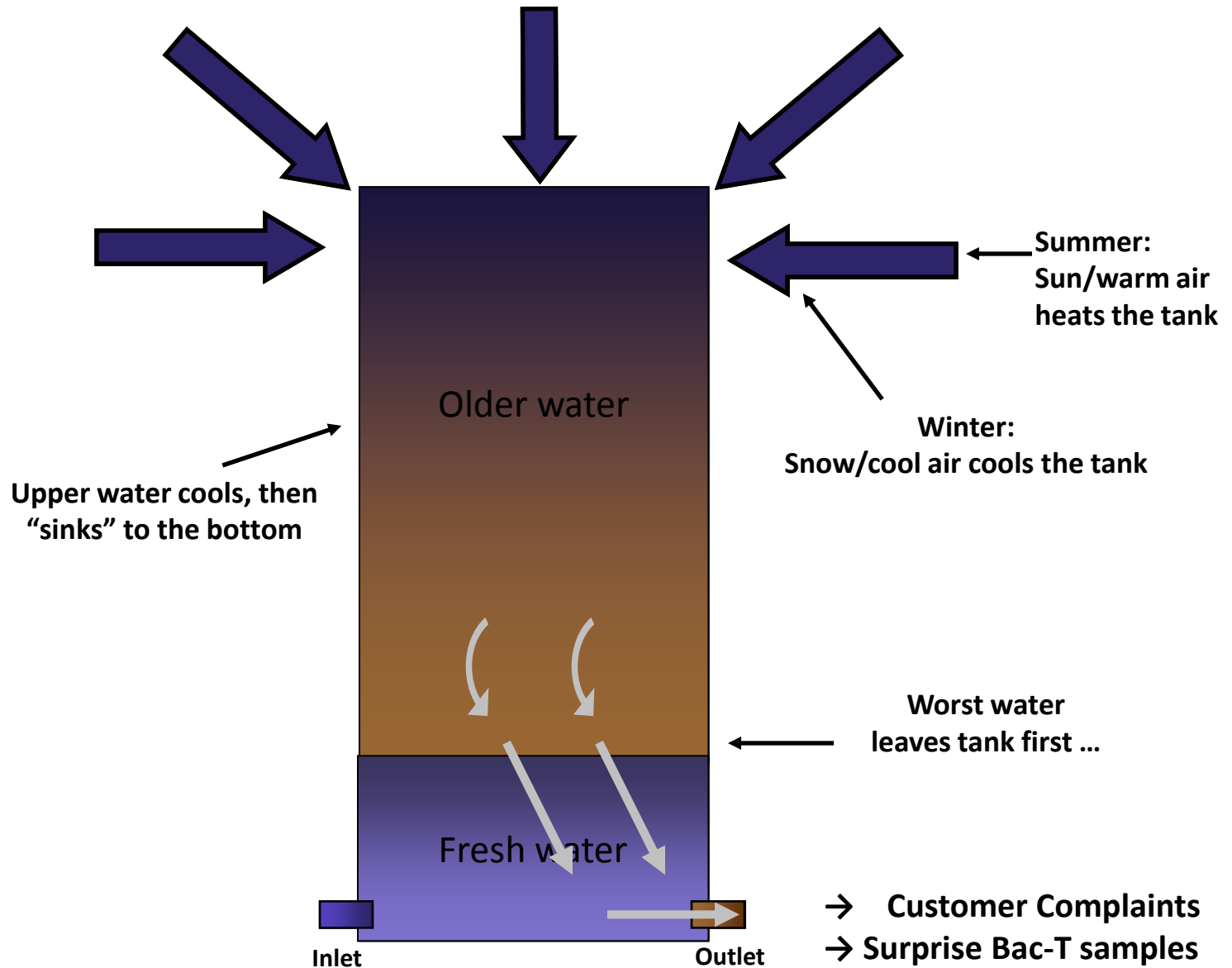

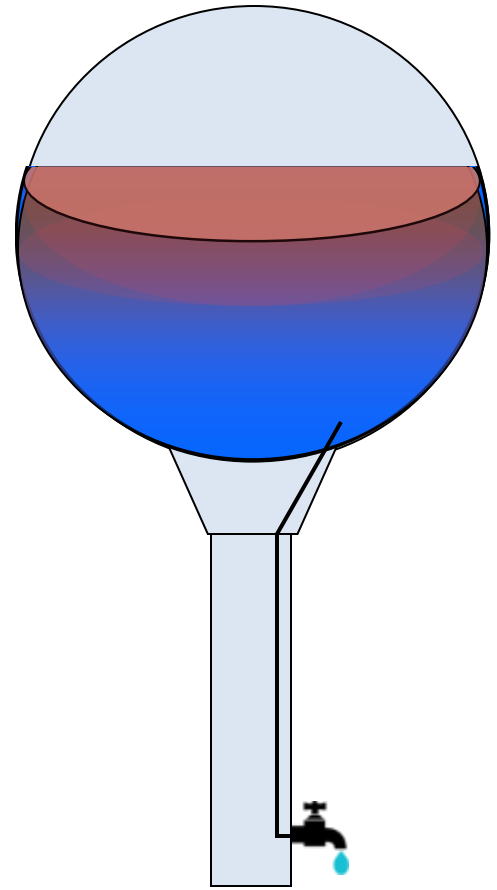
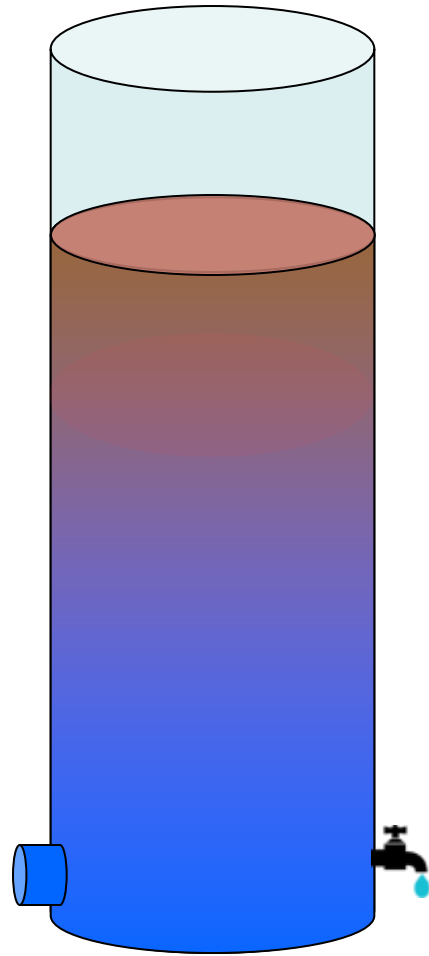
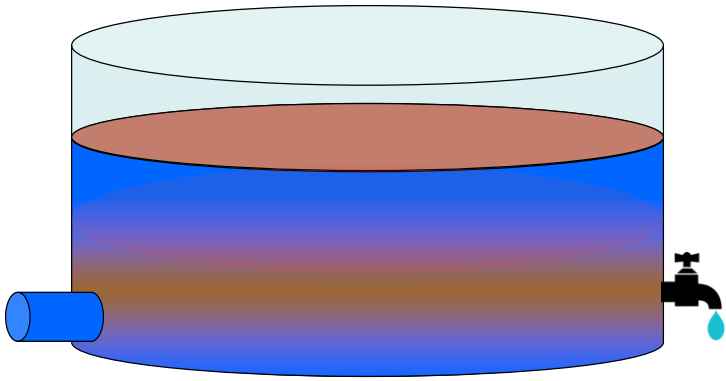

# Why do regulators recommend mixing?

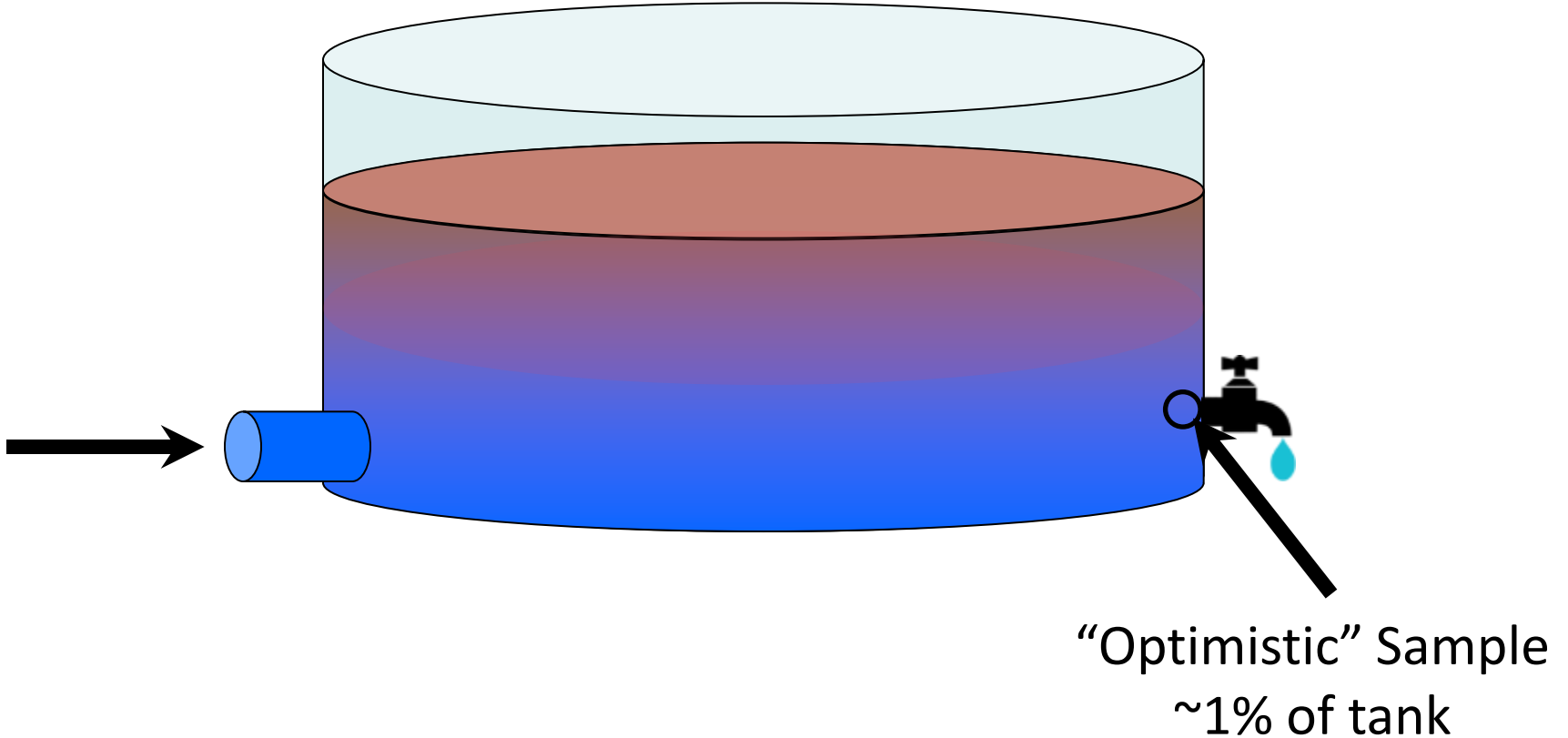

# How did we deal with this problem?

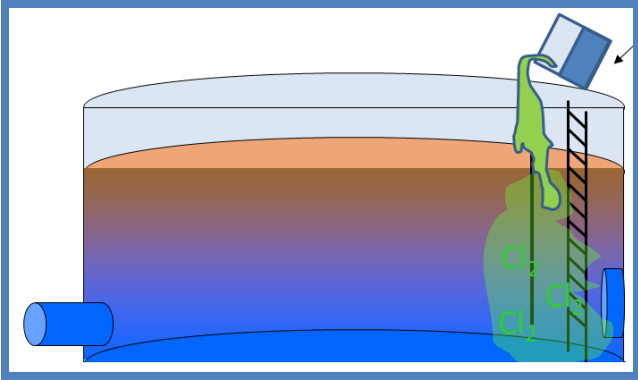

Dose

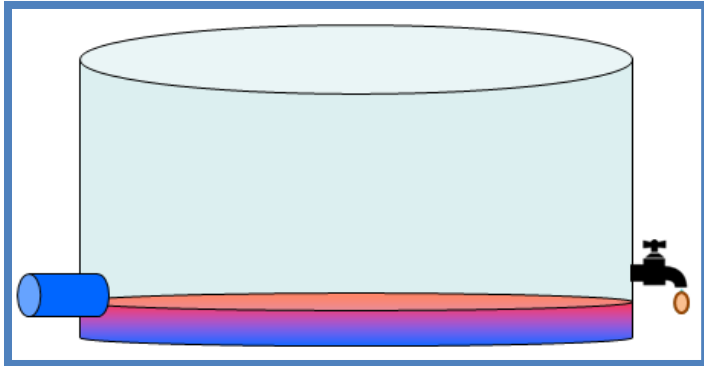

Flush

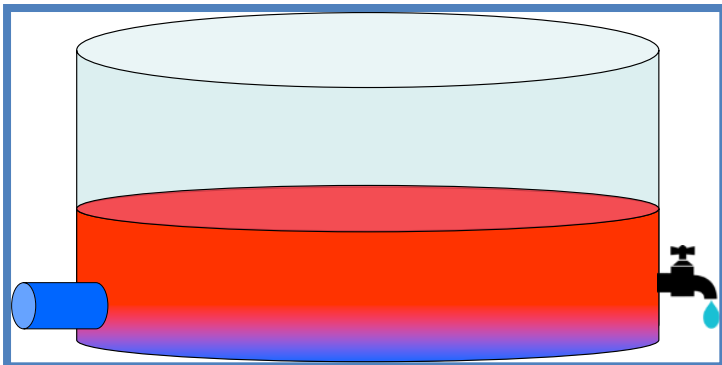

Juggle

- Manual
- Spot-treatments
- Reactionary
- Not “management”



# Innovation for operators

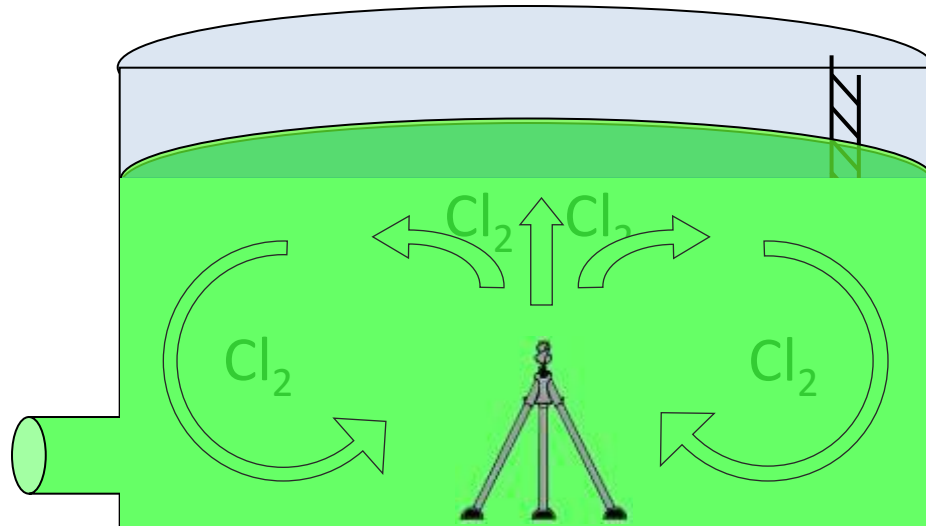

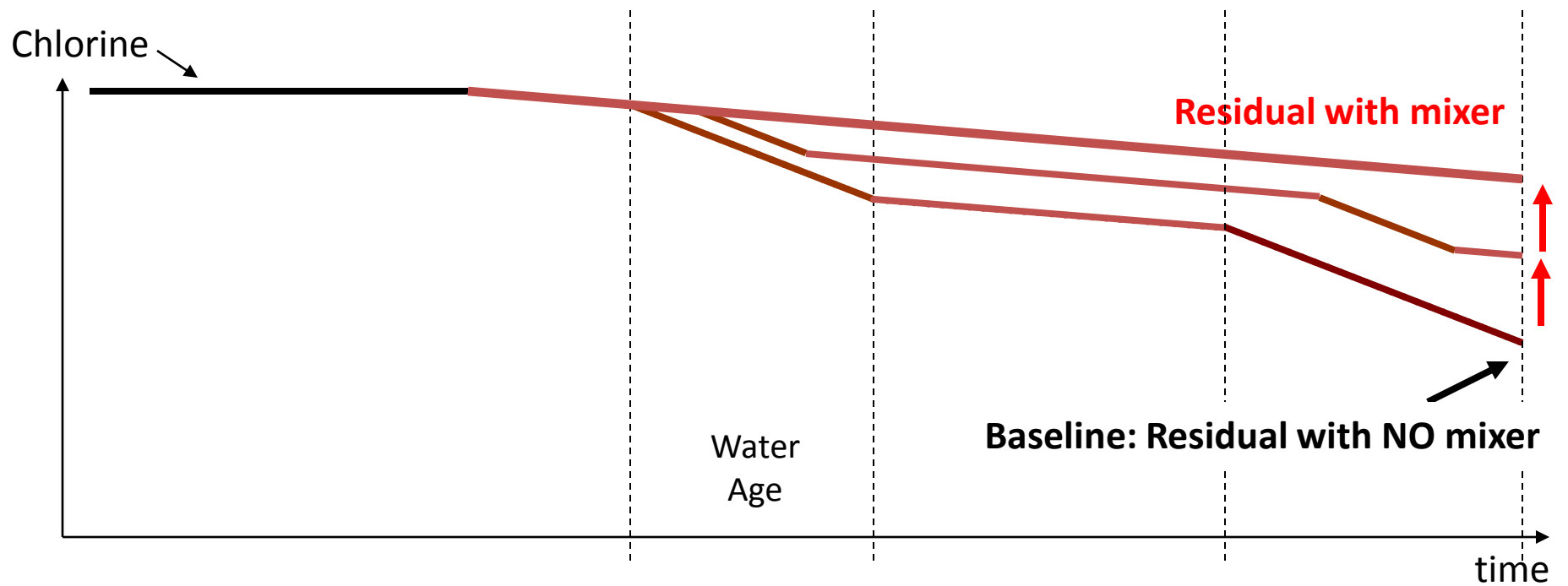
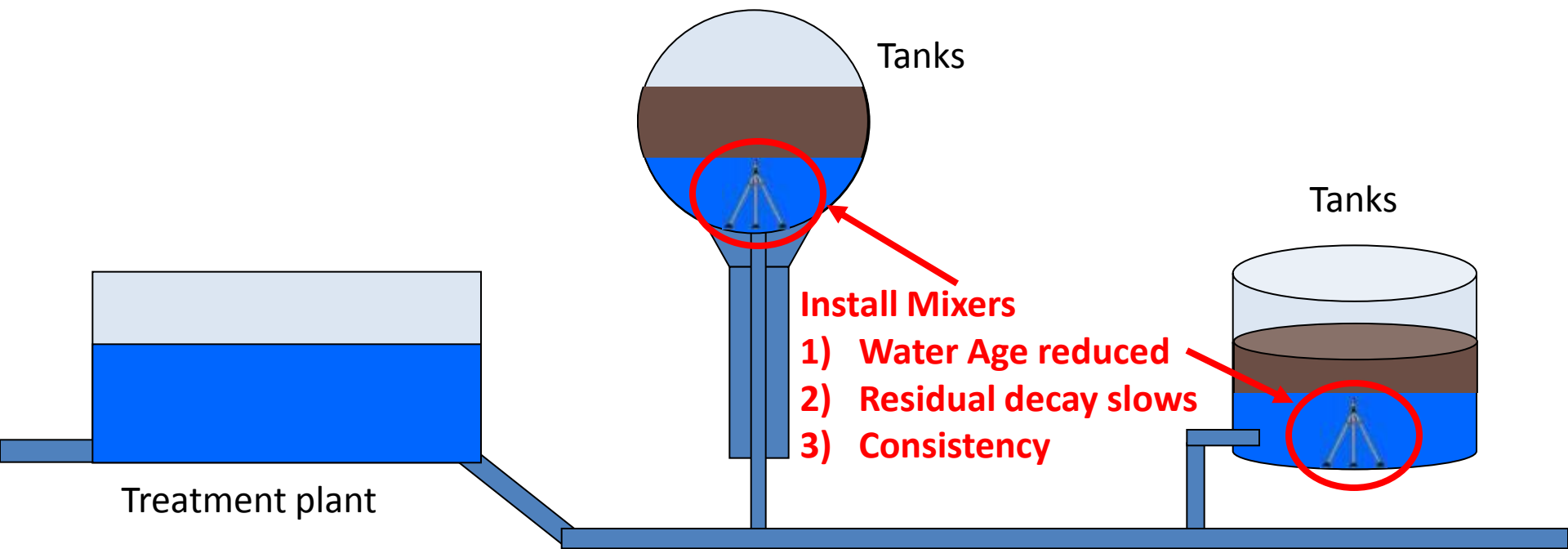

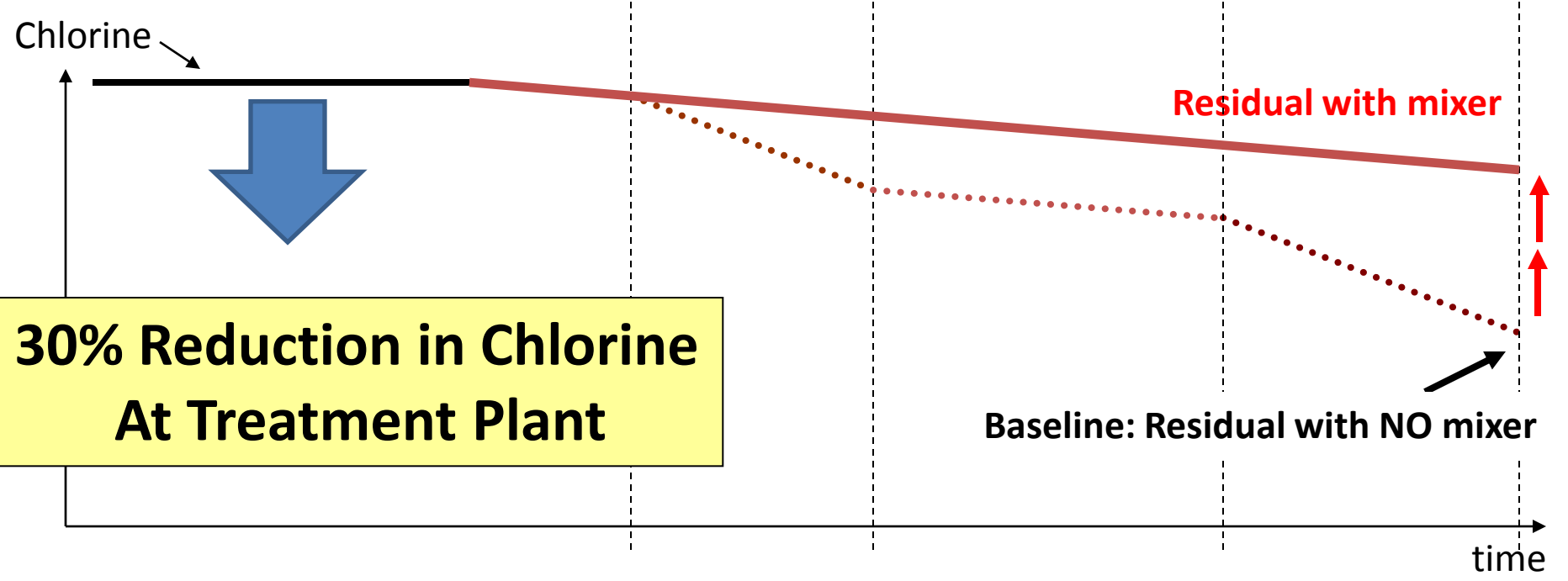
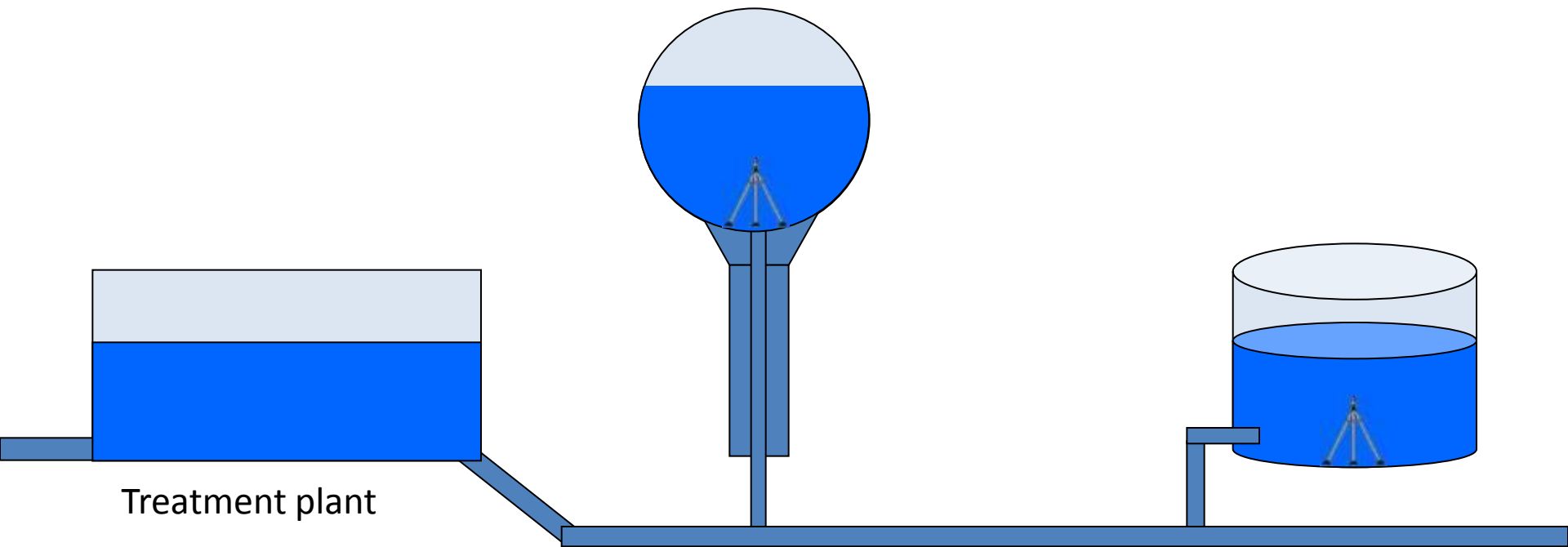

# How much mixing does my client need?

Depends on shape and size of tank

- Small, flat tanks
- Large flat tanks, square tanks
- Standpipes (wide)
- Massive tanks (10 MG+)
- Standpipes (narrow)

Easy  
↓  
Hard

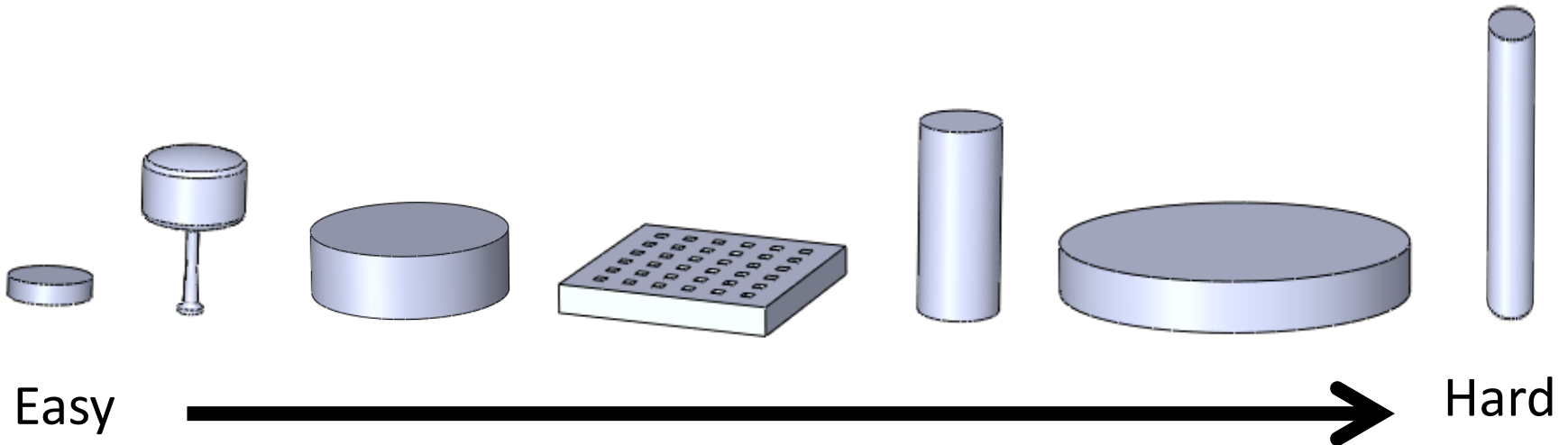

# How much mixing does my client need?

Depends on what they are trying to do

- Maintaining well-mixed conditions
- De-stratification (thermal load)
- Blending a dose
- Aeration/Ice Prevention

Easy  
↓  
Hard

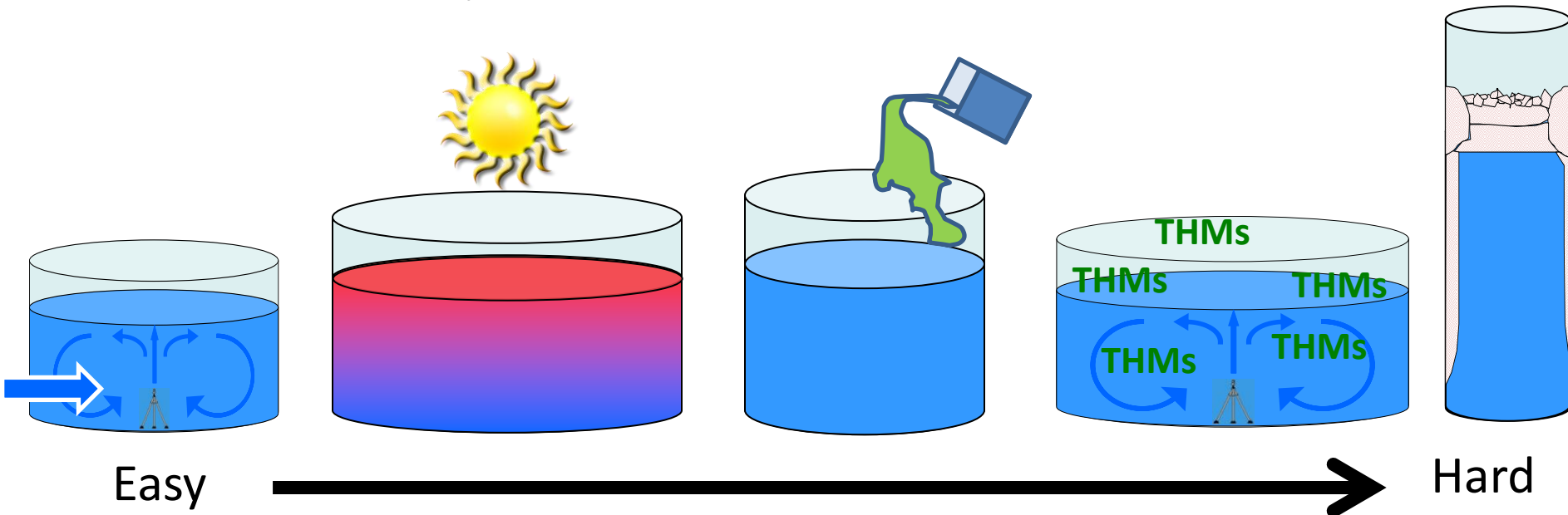

But ... what if mixing isn't enough?

# Three New Technologies for Managing the Distribution System

Mixing

RCS

Reservoir Control System

TRS

THM Removal System

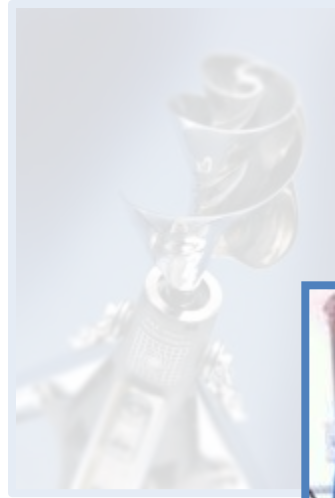

# PAX Reservoir Control System (RCS)

- Monitor chlorine
- Boost chlorine
- Intelligent controls to gradually feed



# Residual Loss in Tanks

Many miles from the treatment plant ....

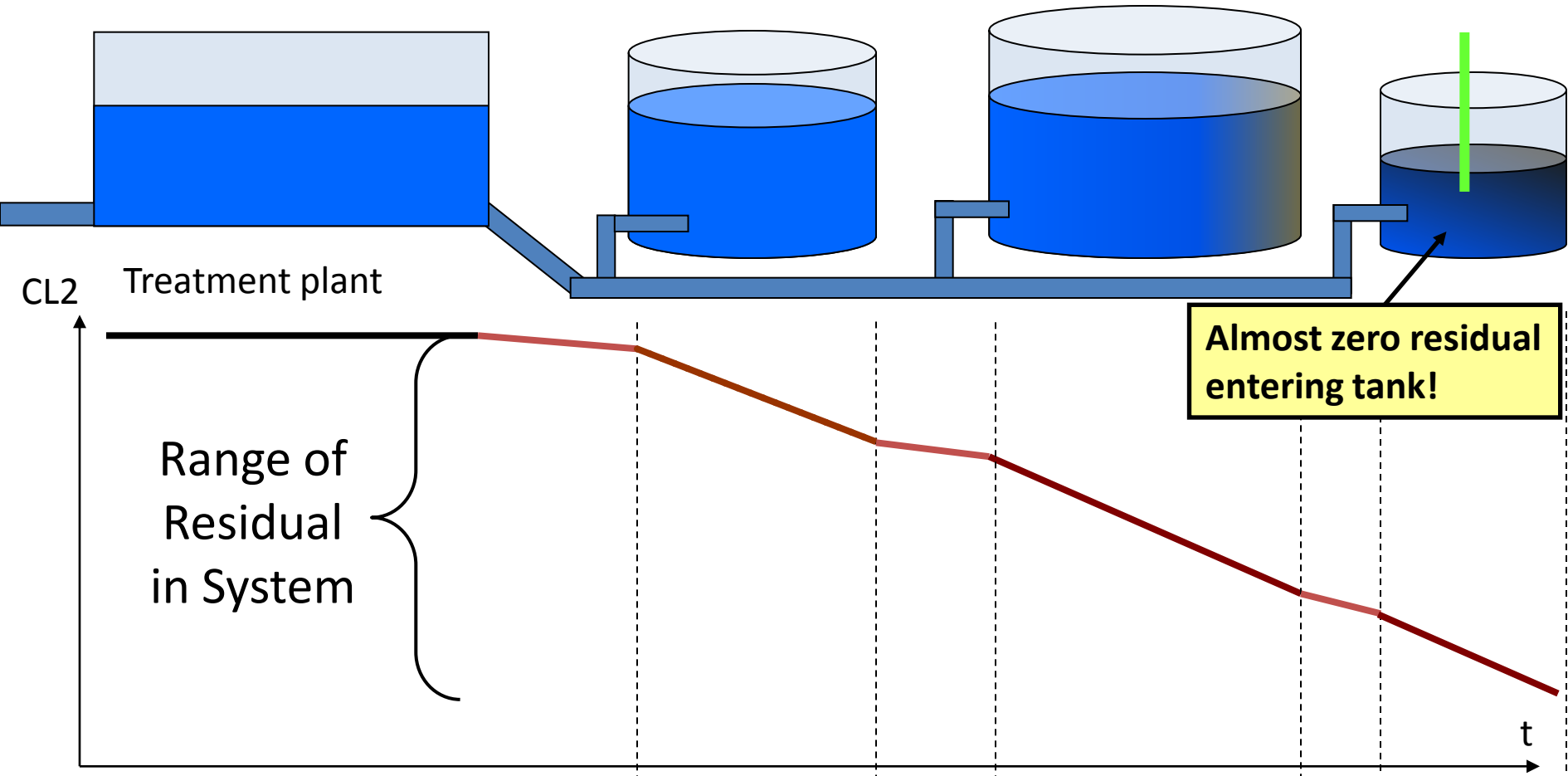

# Residual Loss in Tanks

Many miles from the treatment plant ....

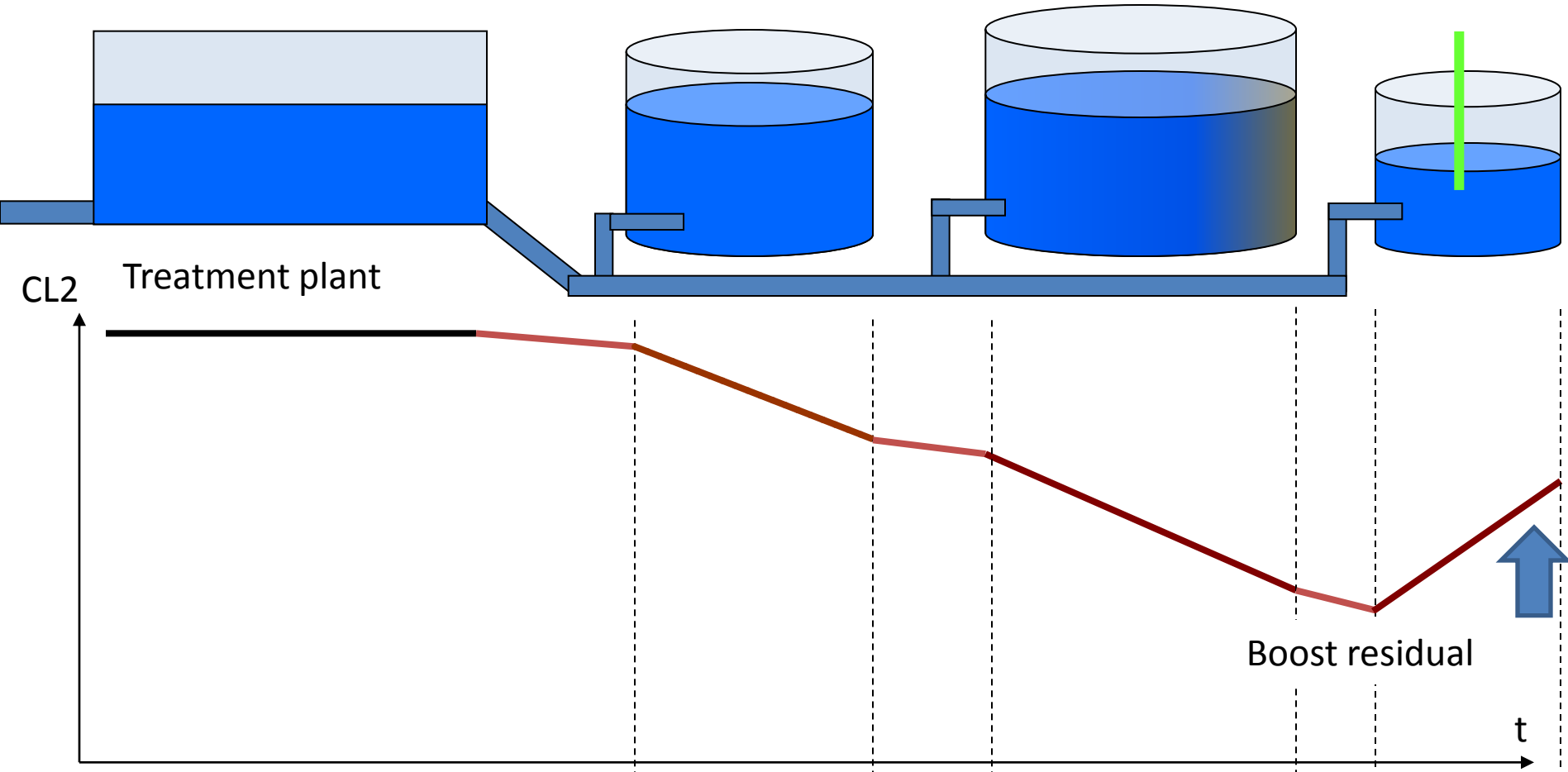

# Residual Loss in Tanks

Many miles from the treatment plant ....

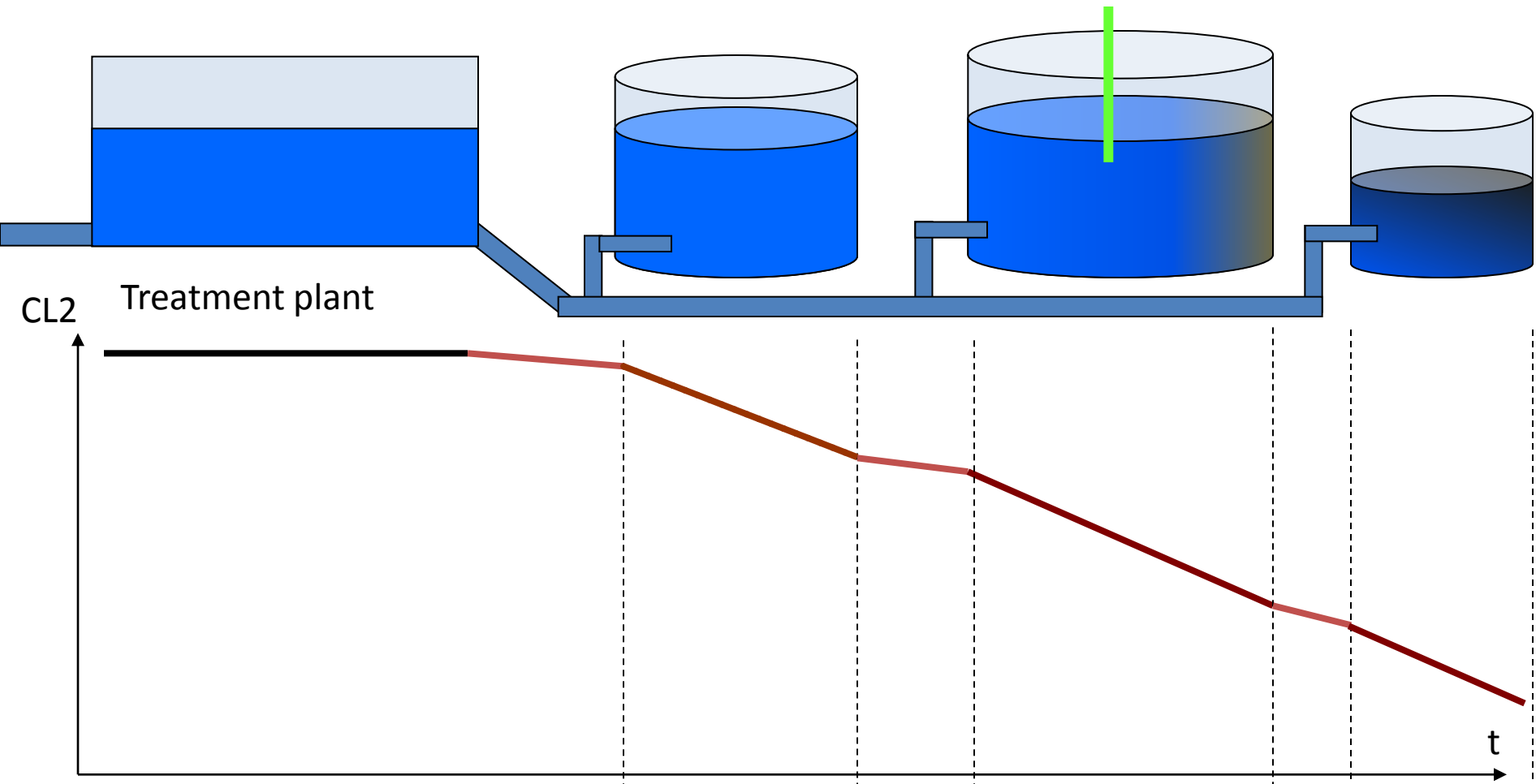

# Residual Loss in Tanks

Many miles from the treatment plant ....

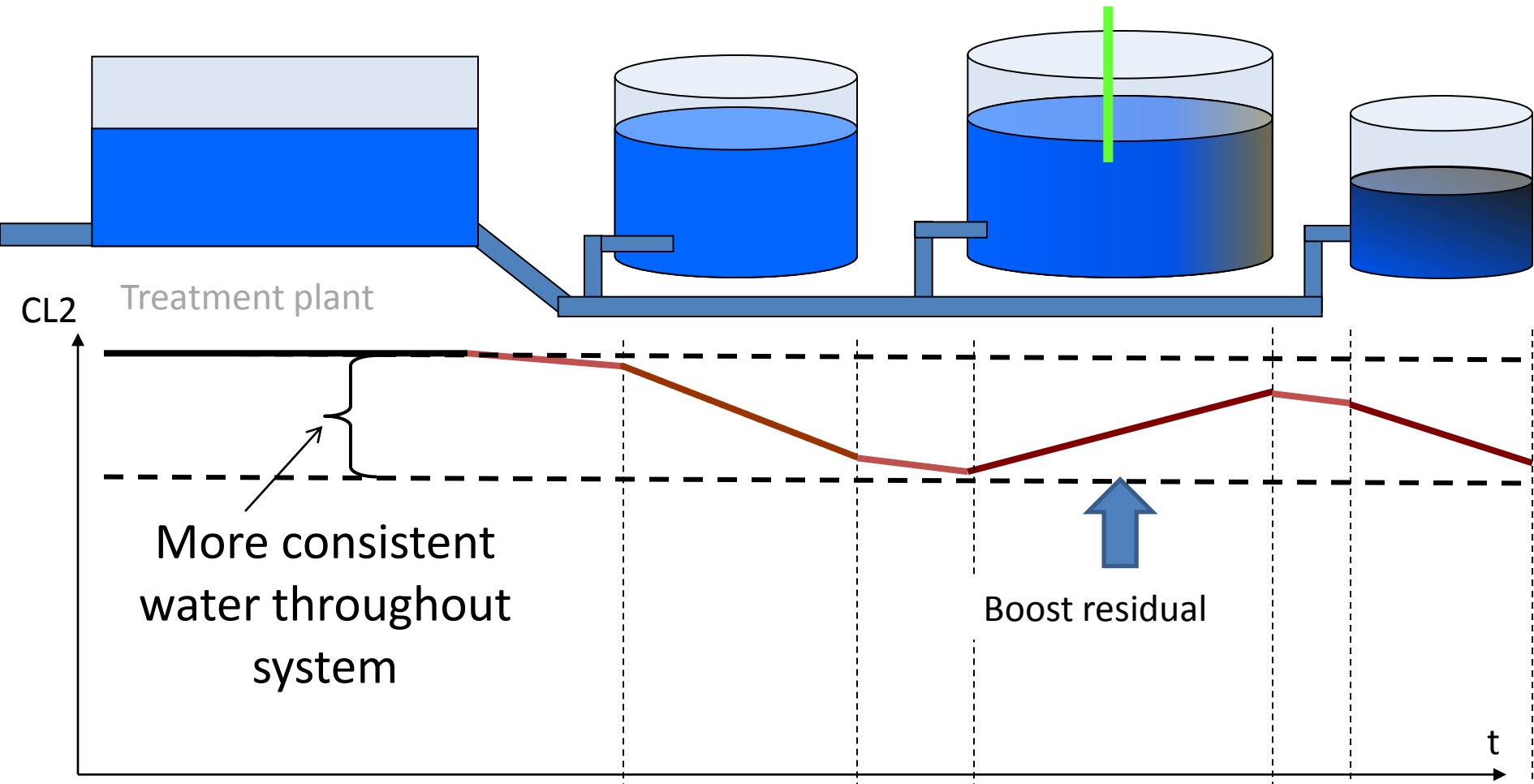

# Residual Loss in Tanks

Many miles from the treatment plant ....

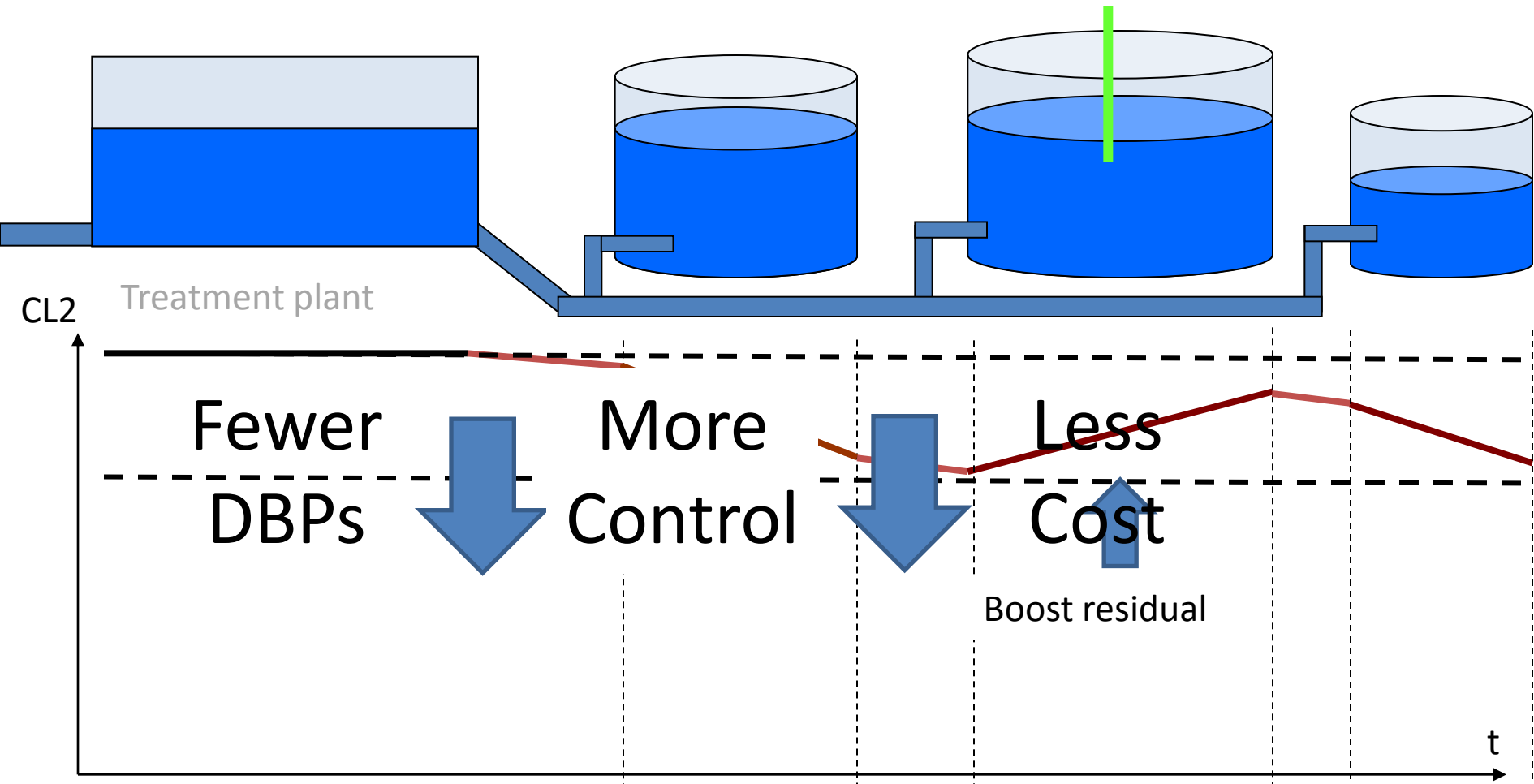

# Mixing + Chemical Injection

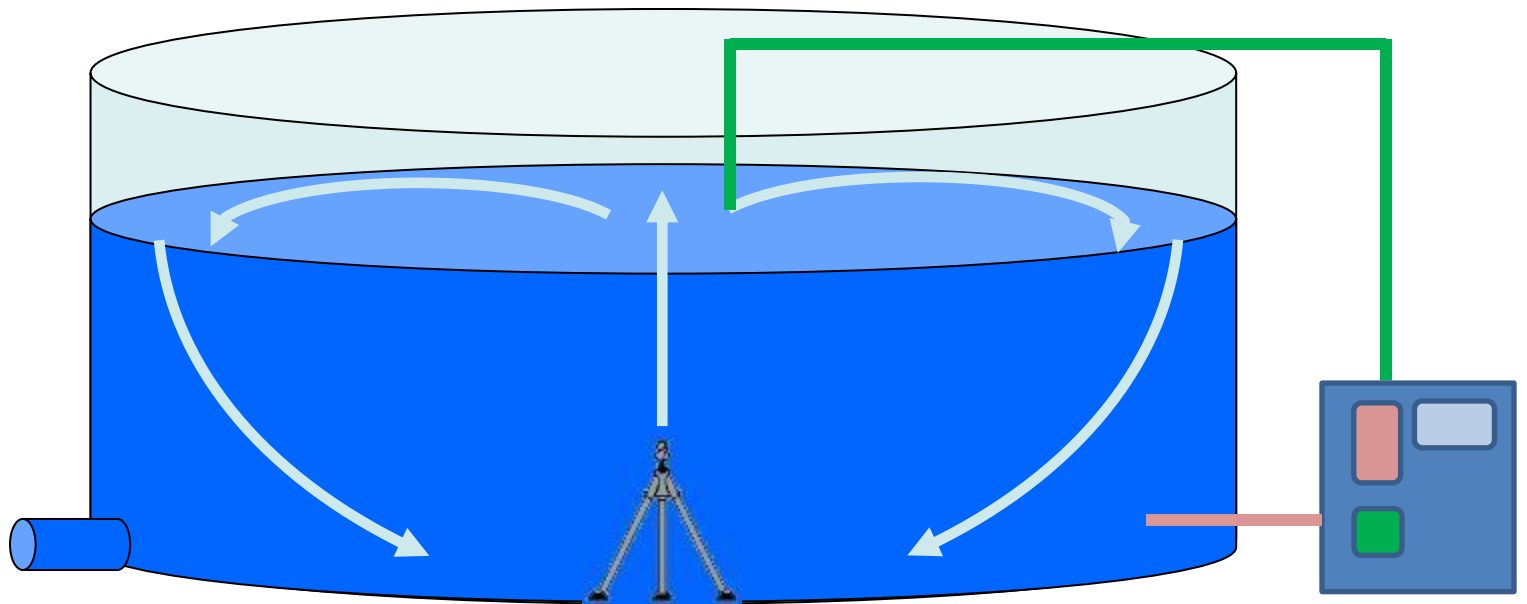



# RCS Installation layout

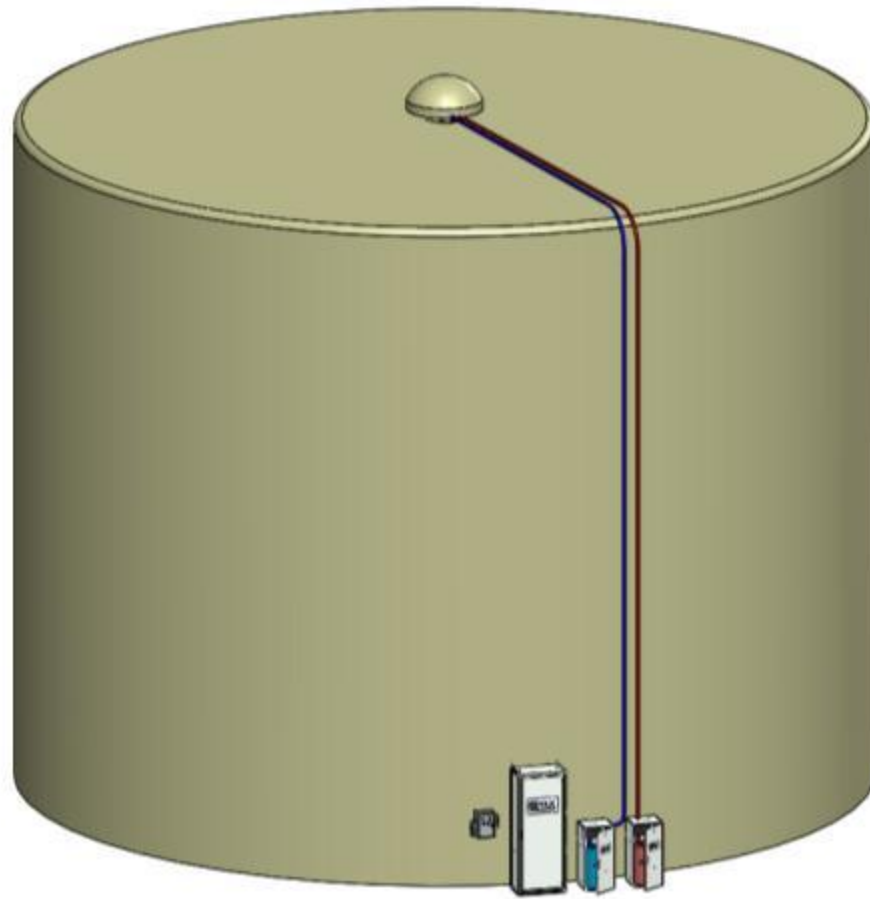

# RCS Installation layout



PAX Mixer

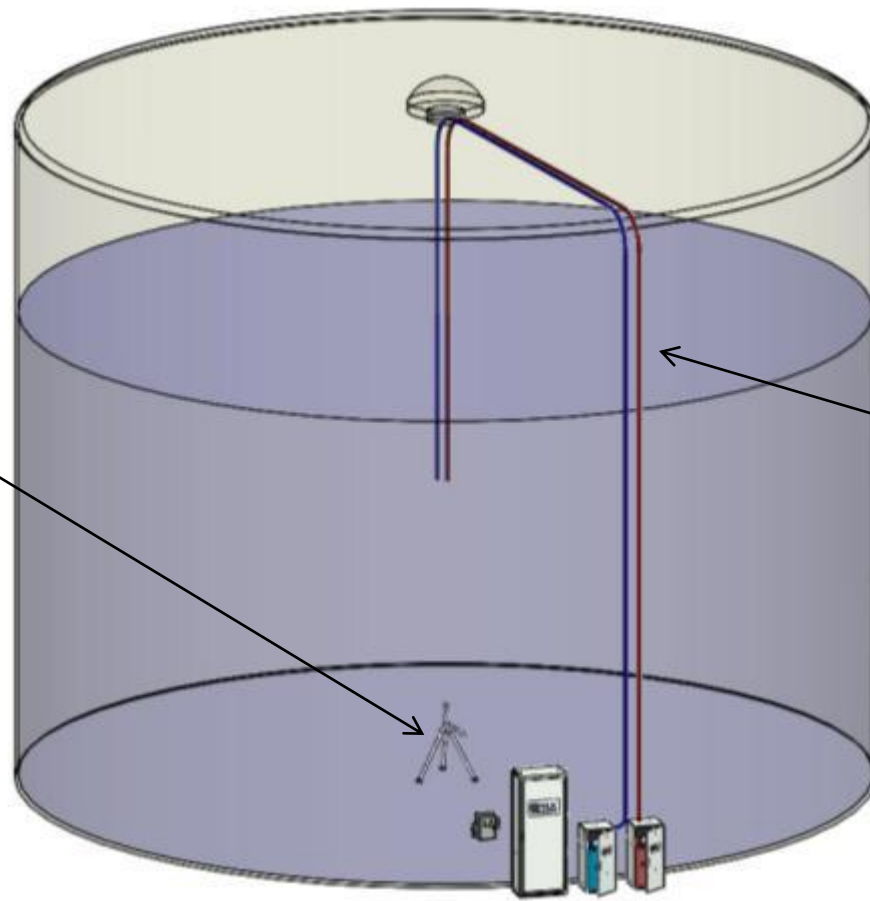

Injection lines

# Complete Mixing Flow Pattern

with option for chemical addition onsite

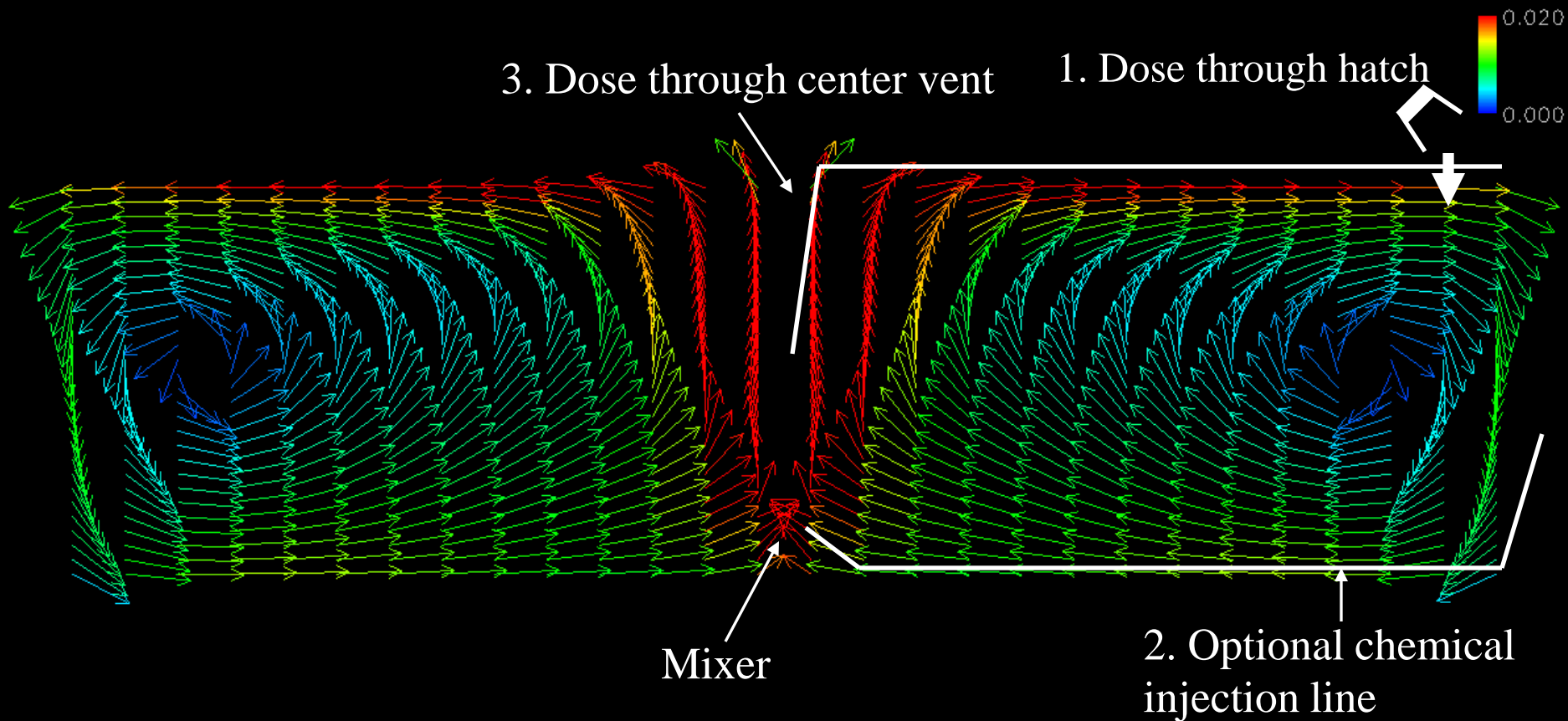

# GREAT for Consecutive Systems

Stabilize this tank at  
1.5 ppm ALWAYS ...





# GREAT when Purchasing Water

Stabilize this tank at  
1.5 ppm ALWAYS ...



# What is the PAX TRS?

hint: nothing to do with Star Trek

# Three New Technologies for Managing the Distribution System

Mixing

RCS

Reservoir Control System

TRS

THM Removal System

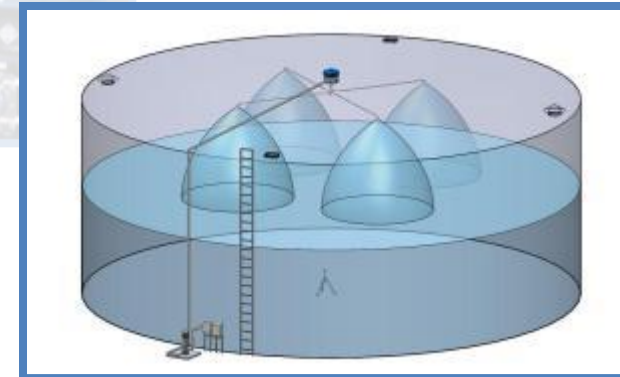



# Take control of your THMs

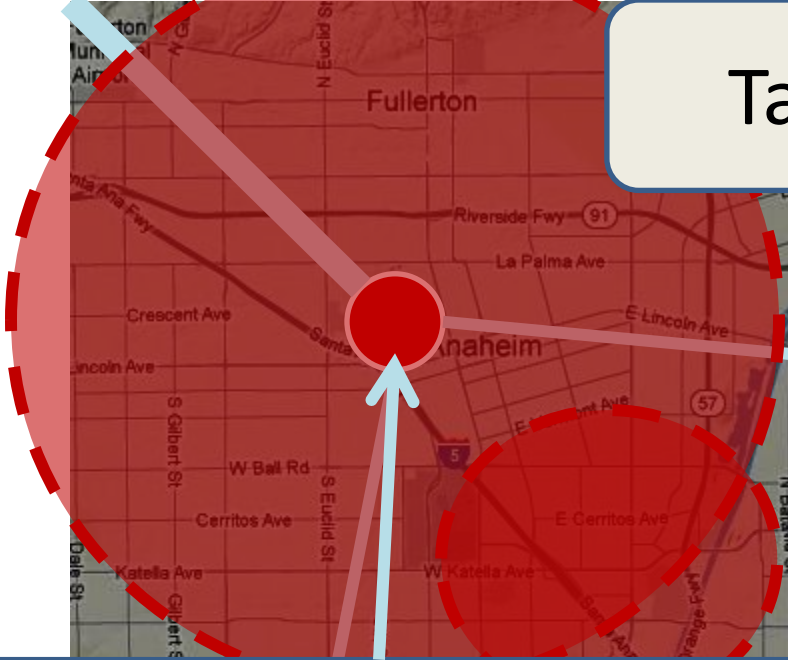

**Option 2:  
Tackle in Distr. System**



**Option 1:  
Tackle at Treatment Plant**

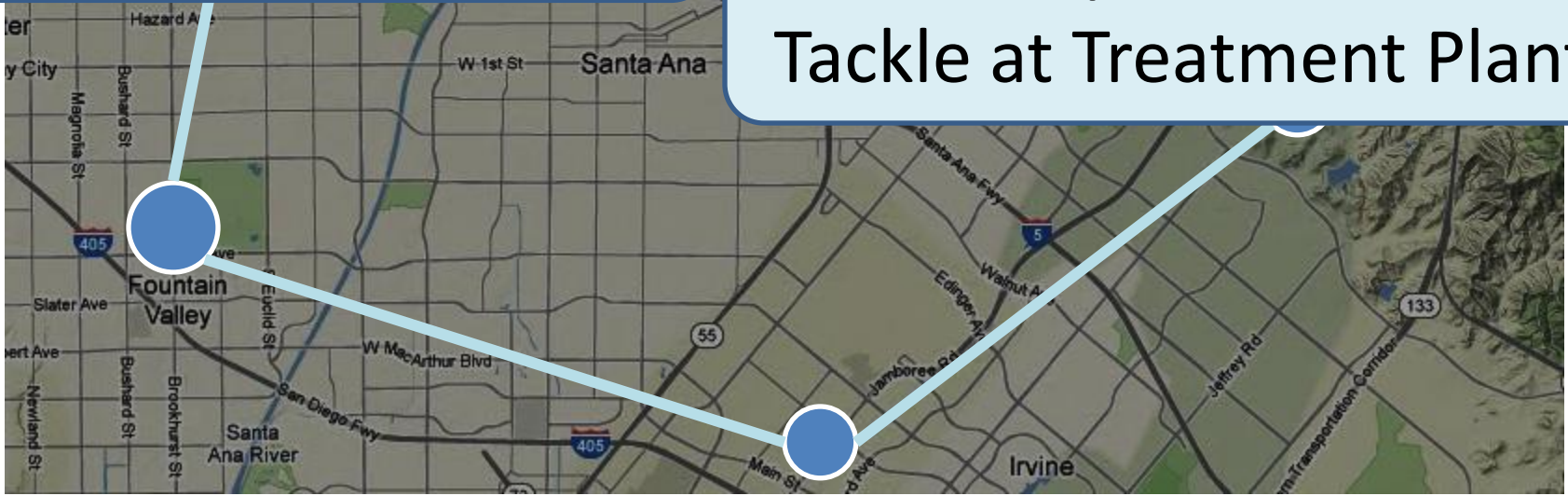



# Tanks are a FREE air/water interface

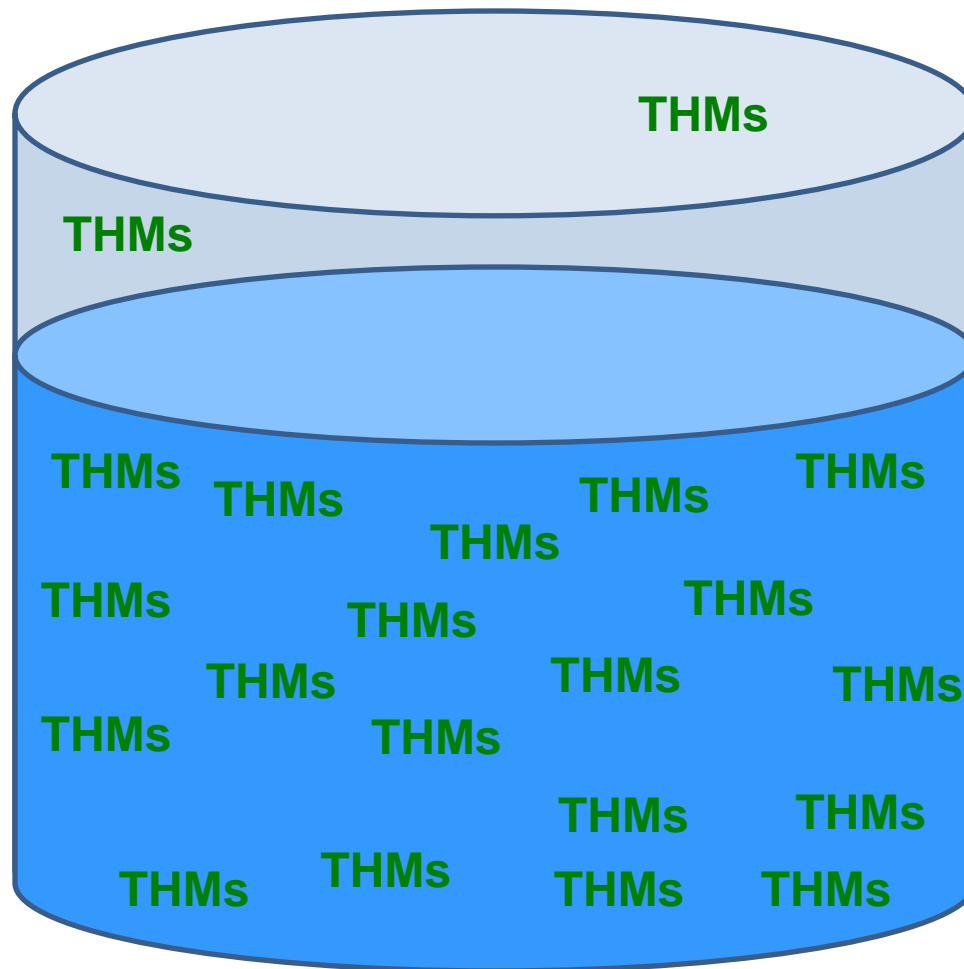

# THMs are volatile ...

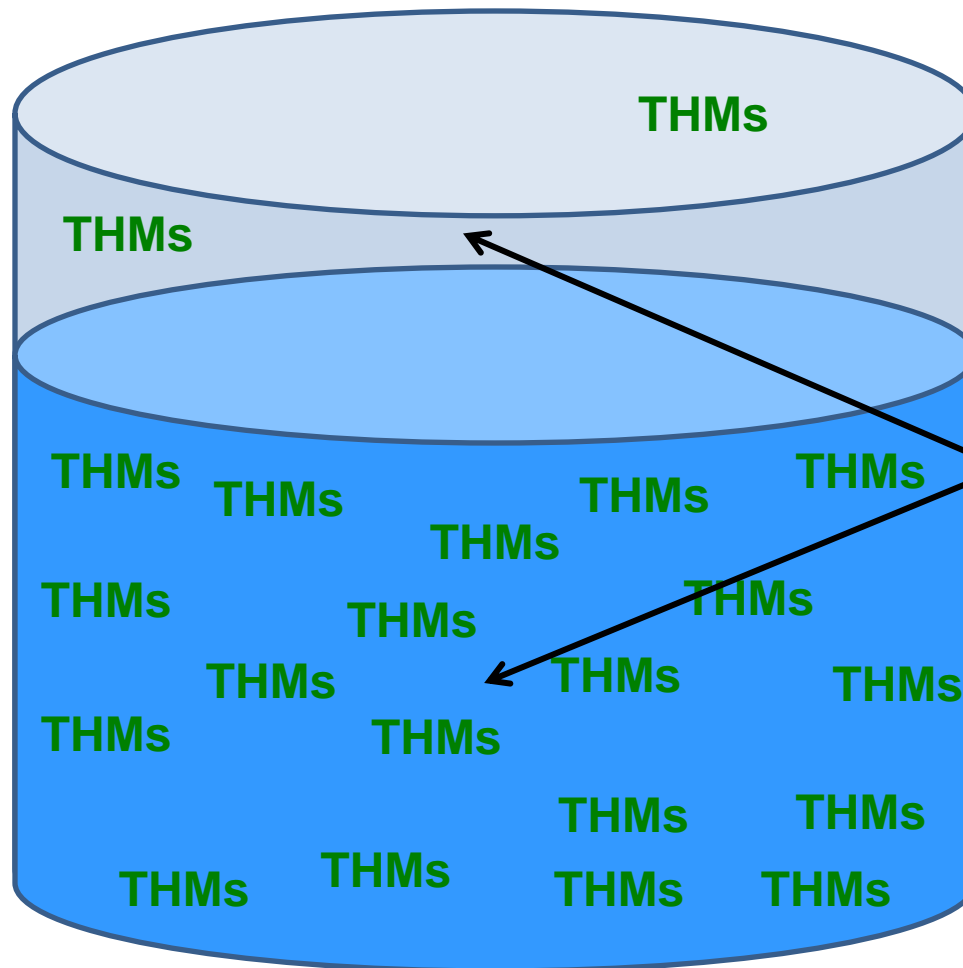

At equilibrium, a ratio in THM concentration between the air and the water That ratio is the **Henry's Law constant**

# Henry's Law constants for THMs

THM species	Henry's law constant @ 20 °C
Chloroform	0.13
Bromodichloromethane	0.08
Chlorodibromomethane	0.04
Bromoform	0.02

**Chloroform is the most  
“volatile”  
(easiest to remove)**

**Bromoform is the least  
“volatile”  
(hardest to remove)**

# Some aeration happens all by itself...

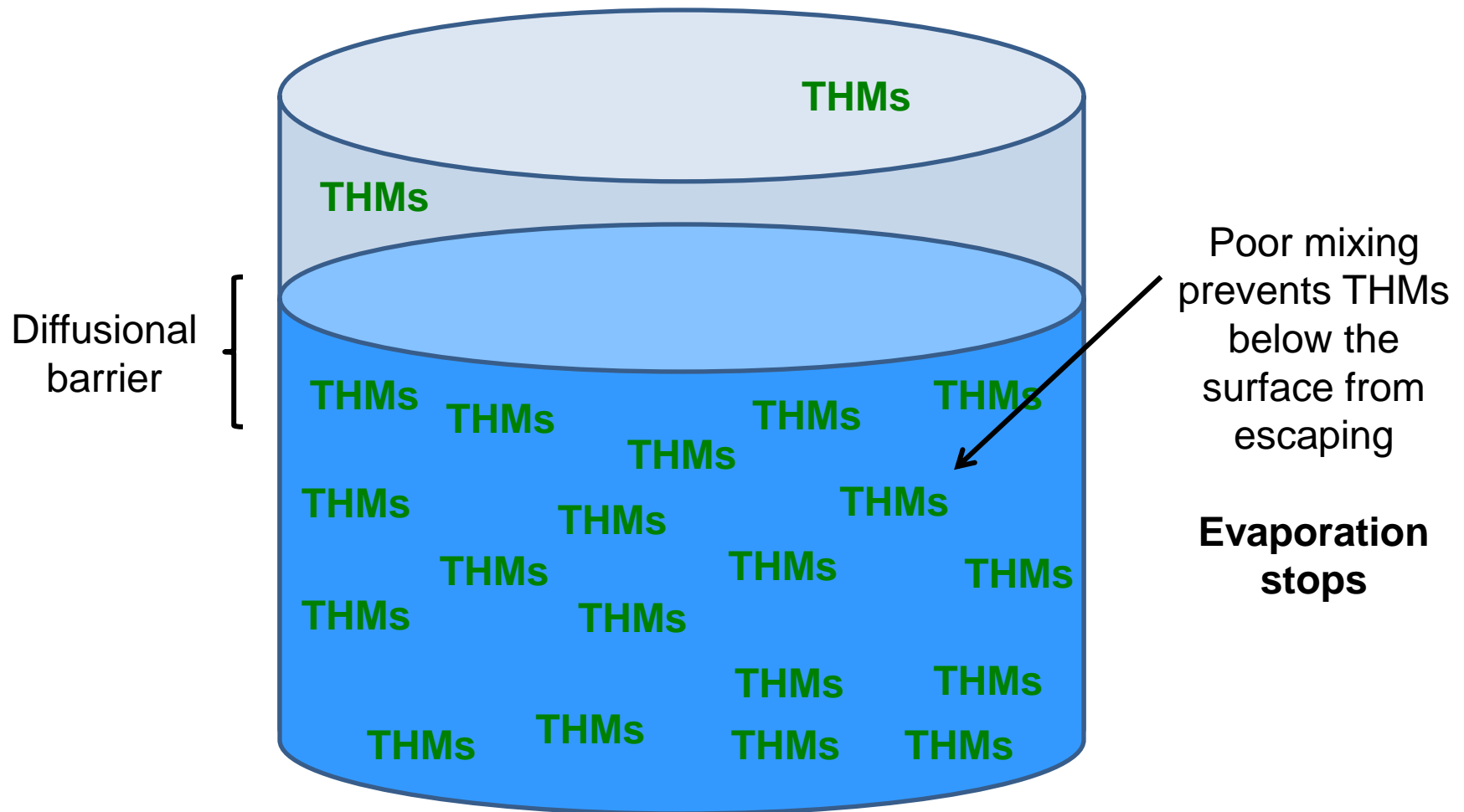

# Powerful Mixing Enhances Aeration (5-10%)

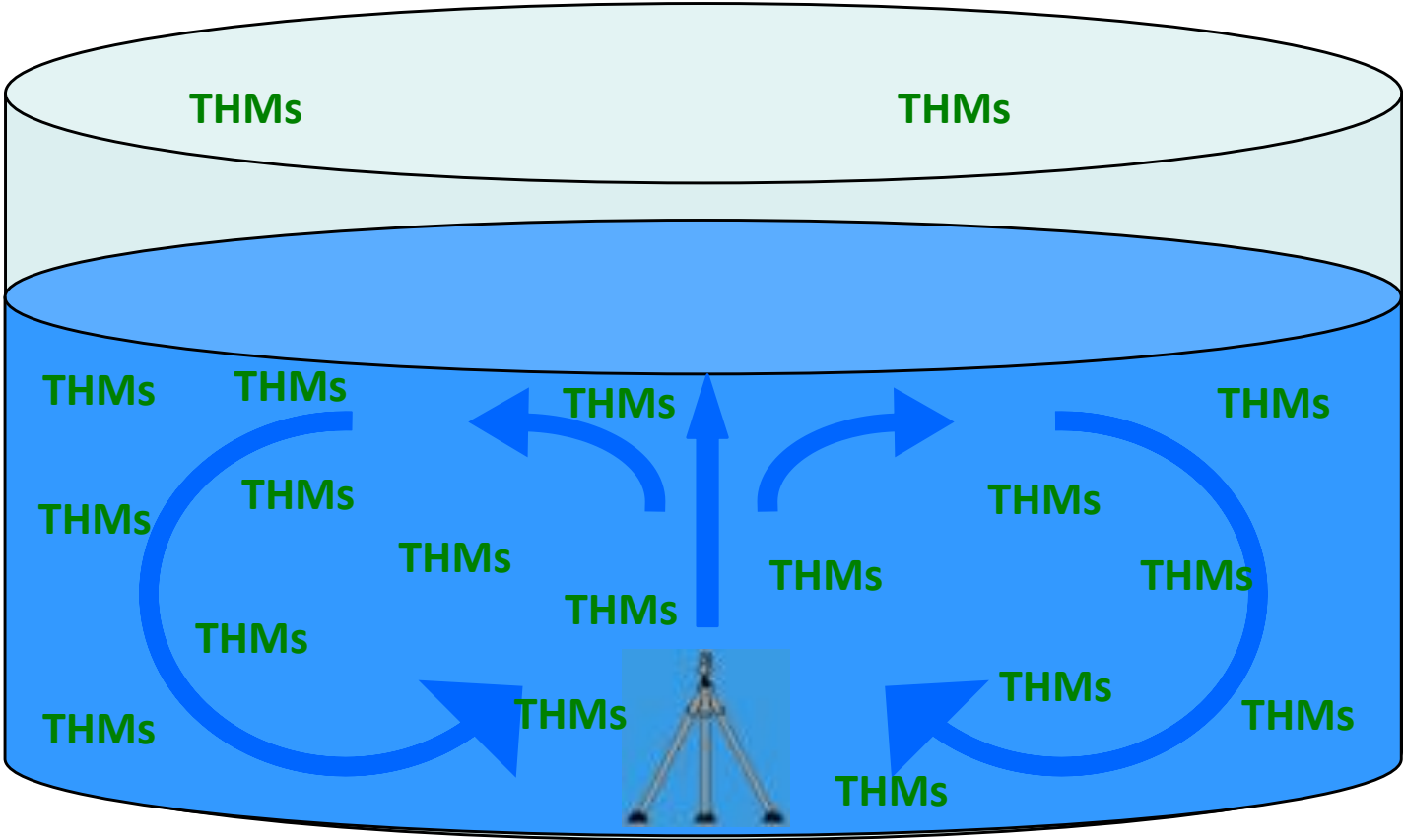



# Different In-tank Aeration Technologies

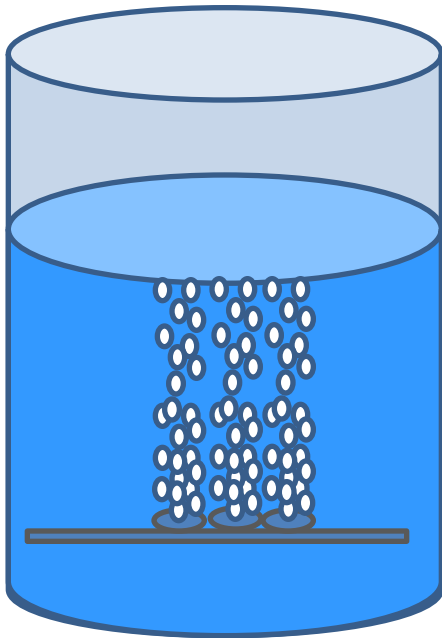

Bubble aeration

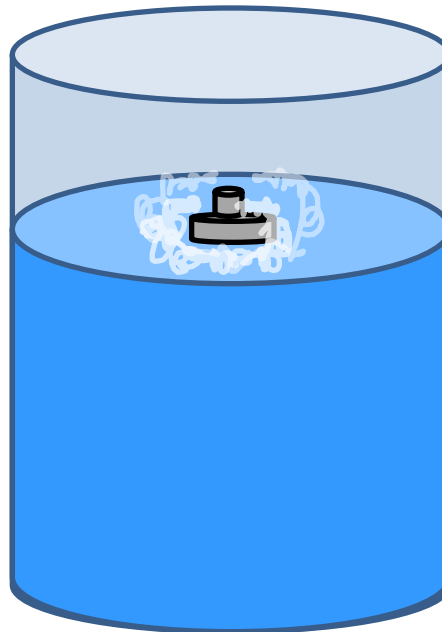

Surface aeration

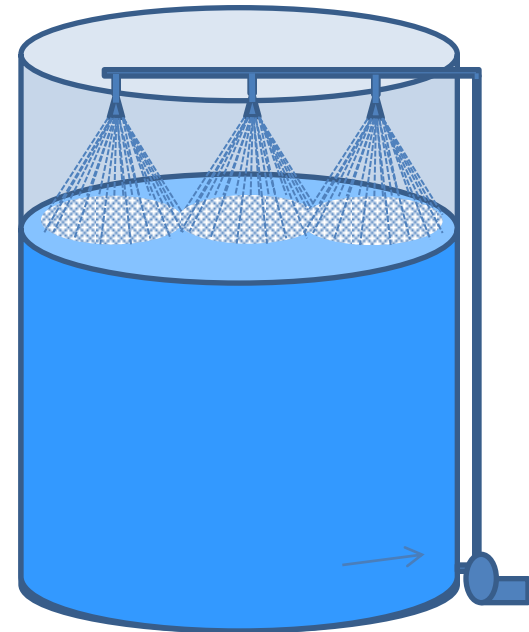

Spray aeration

Any of these technologies can be made to work...  
but capital and energy costs vary greatly

# Bubble aeration – How it works

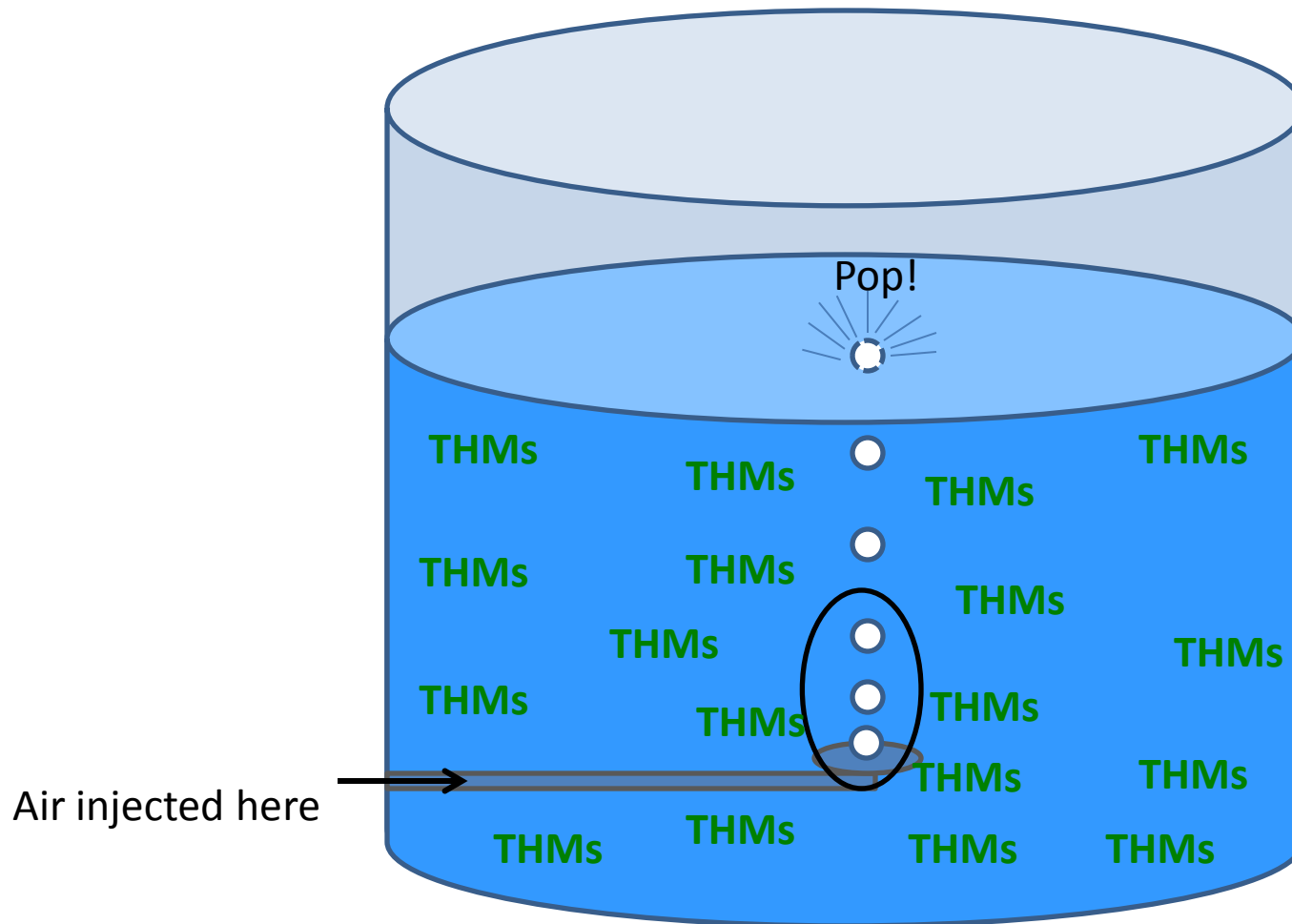

# Surface Aeration – Mixing needed

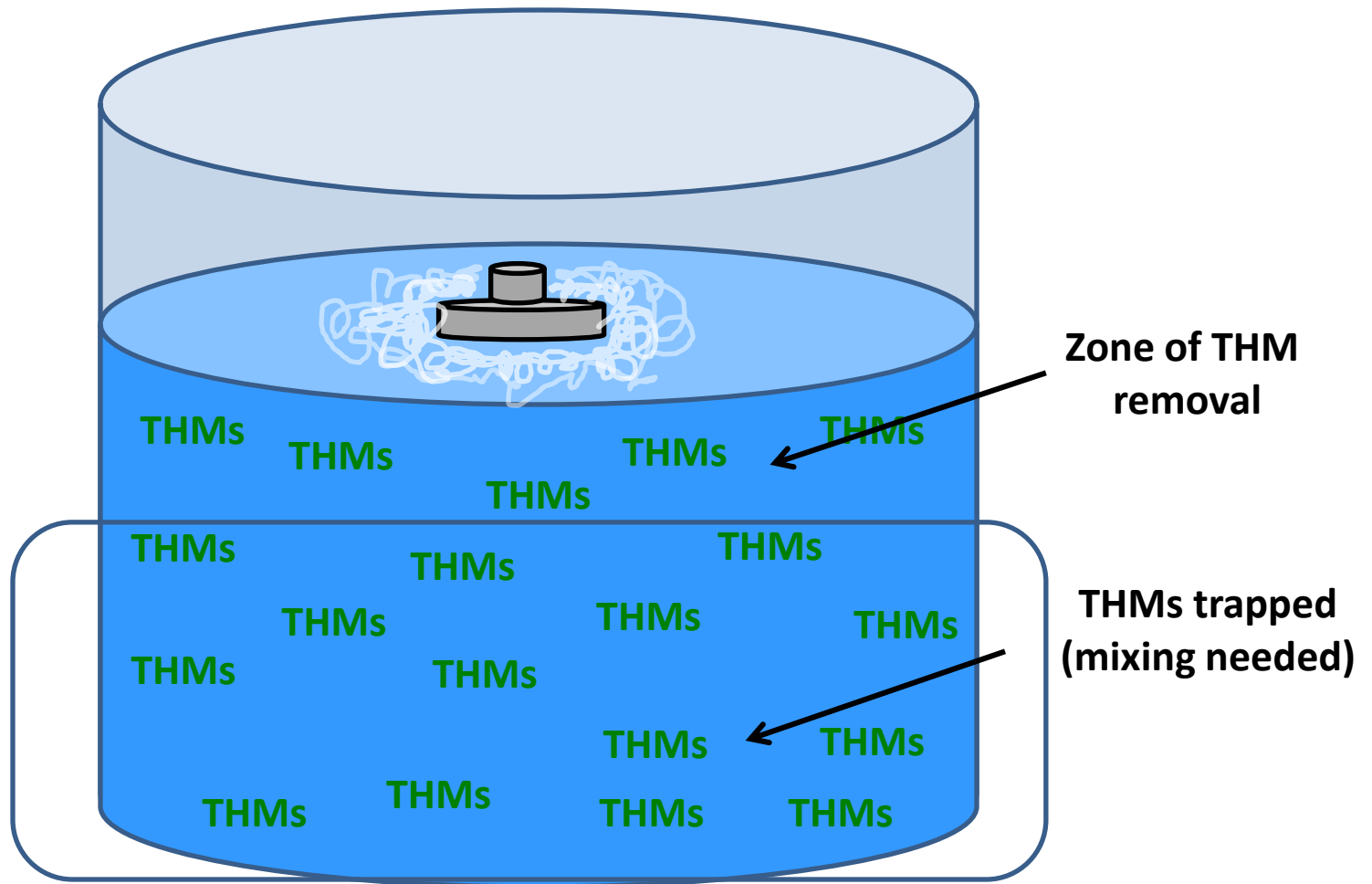

# Spray Aeration

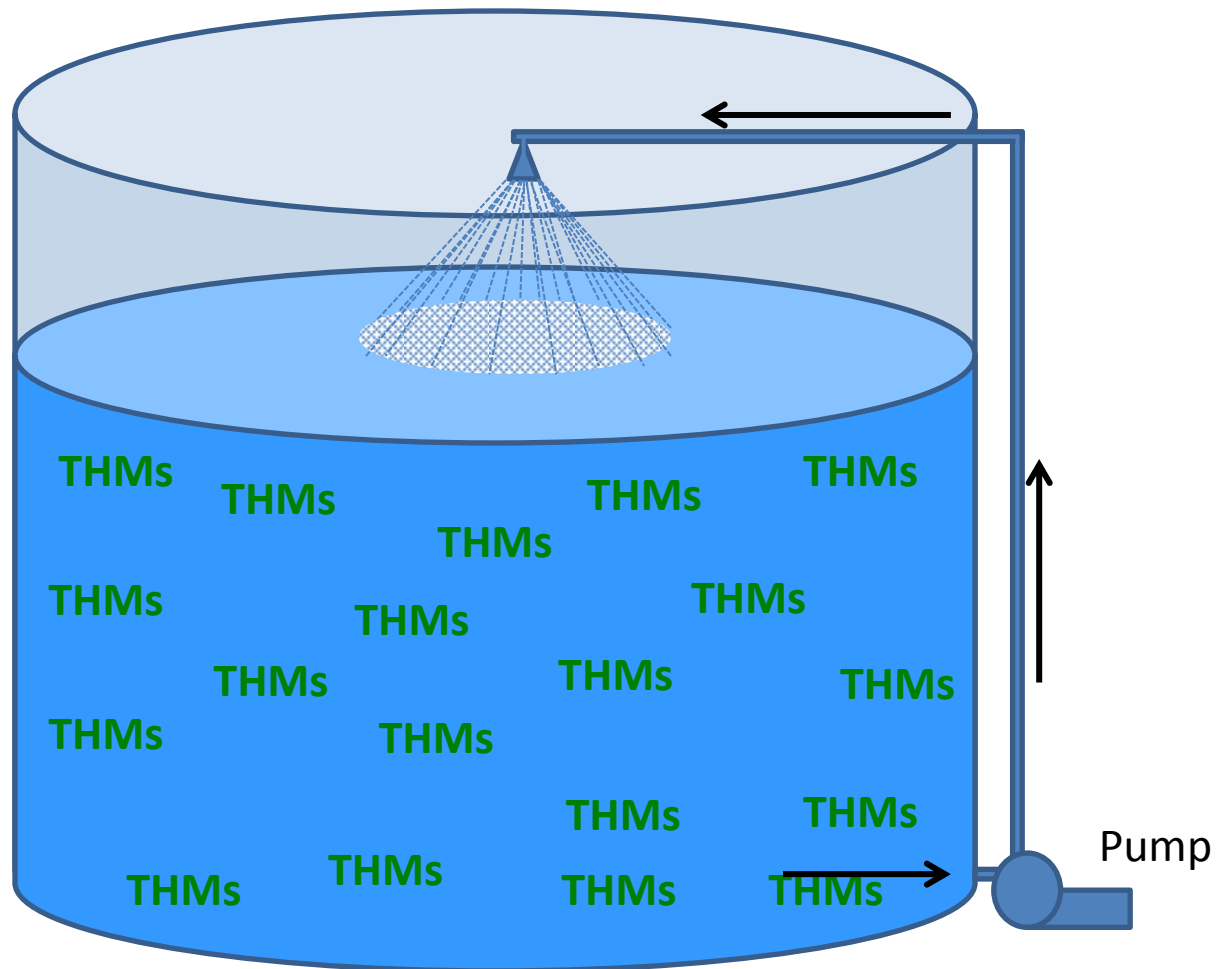

# CFD for Tank Aeration



Spraying  
efficiency (X)

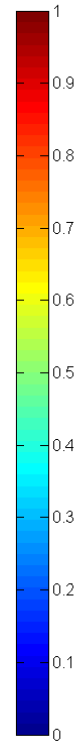

# Model shows accurate removal

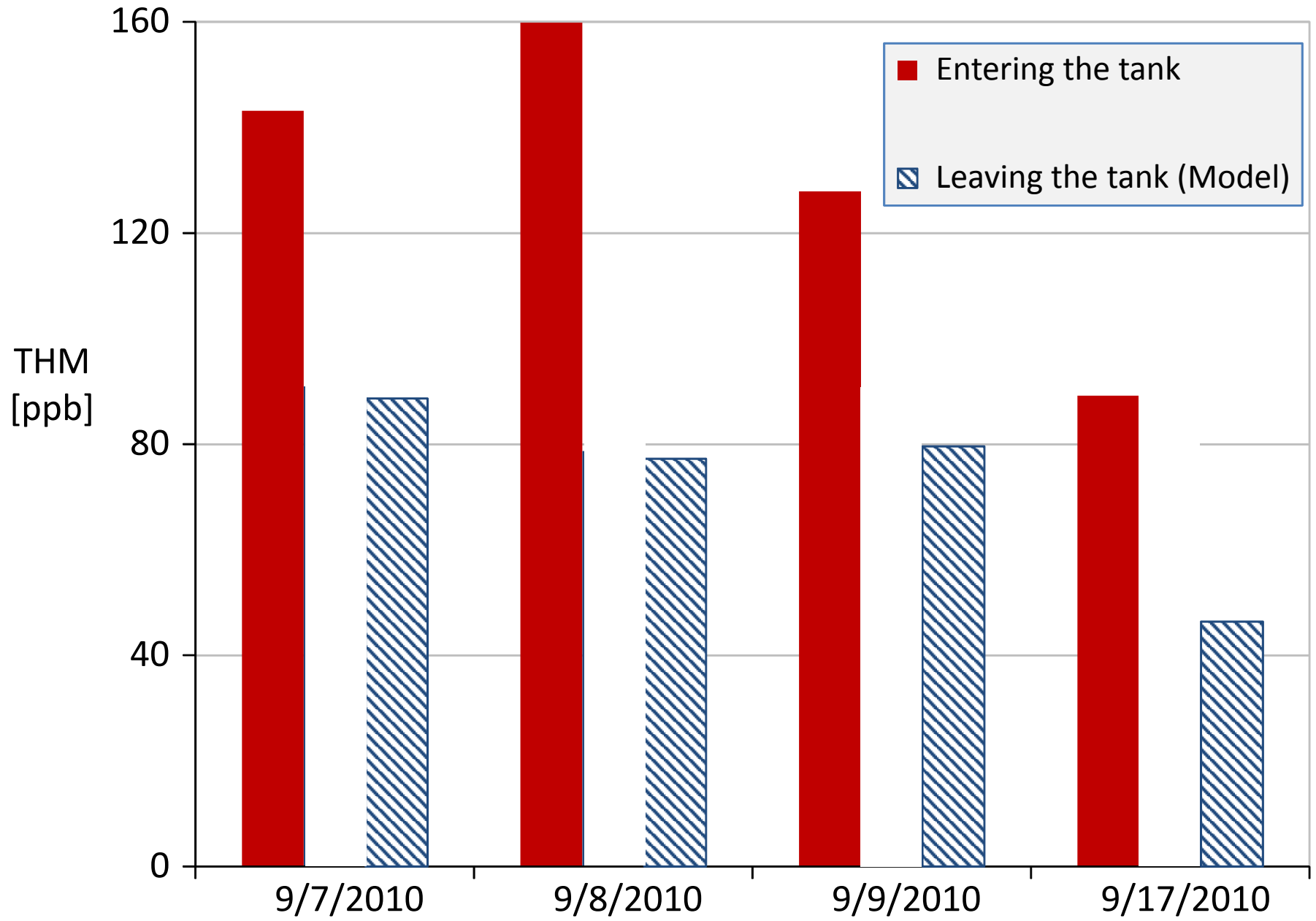





# What are the other options?

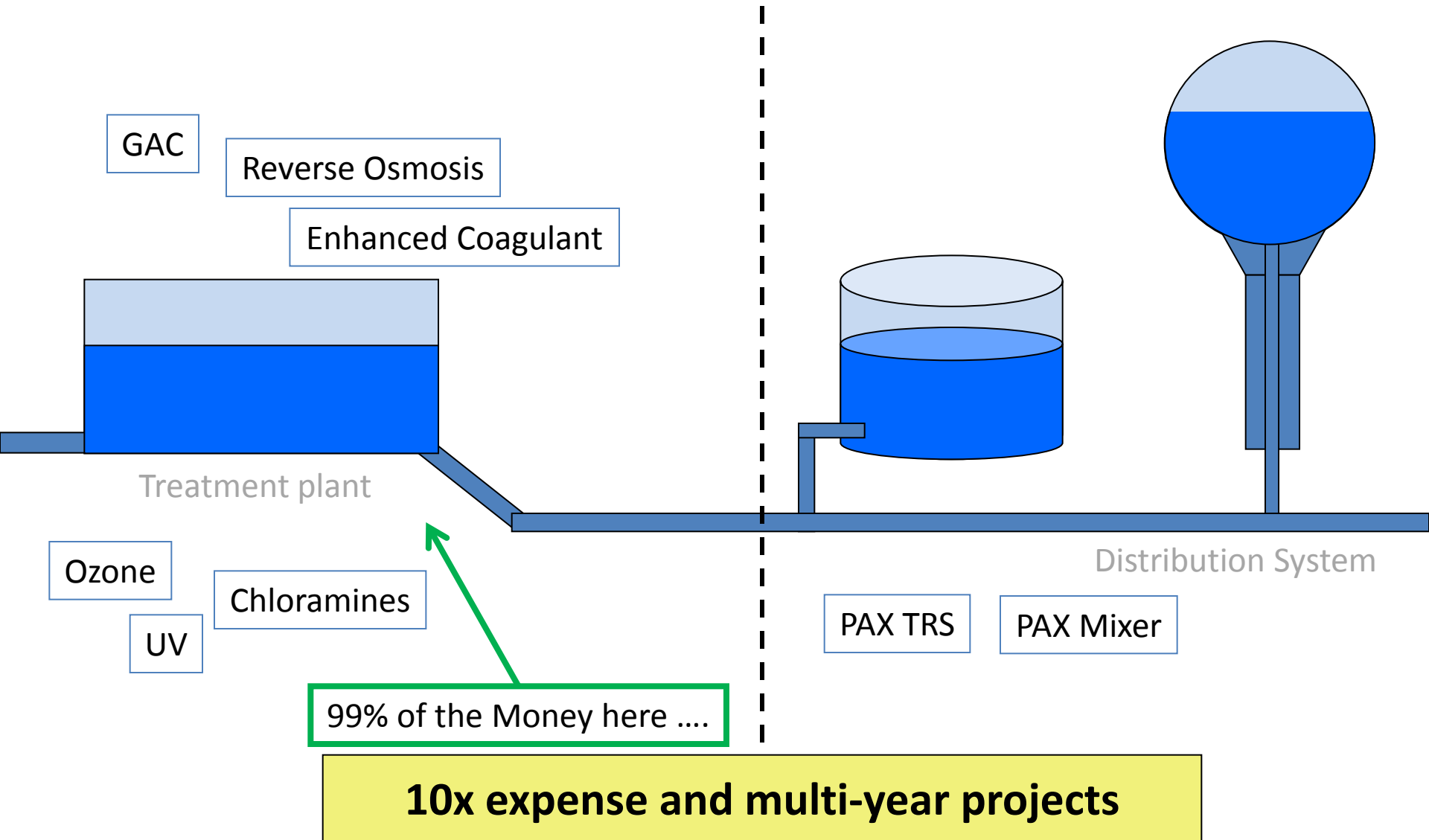

In summary ...

*Welcome to the 21st century  
treatment site*

*Maintain  
(Boost)  
(Improve)*



# Contact

- Teresa Corrington
- (253) 779-4160



- John Kitchen
- (503) 577-4194







# PAX Mixer – The Active Solution



## Mixer Details

Stainless Steel 316

Installs easily through hatch

Sits on foot-pads, no attachment/scratching

60 Lbs, 4 feet tall

## Power Source

DC Motor

1/3 HP, \$0.50/day

Water-filled motor (no leaks)

5 yr warranty, 15 year expected life





# PAX - Any Tank, Any Size

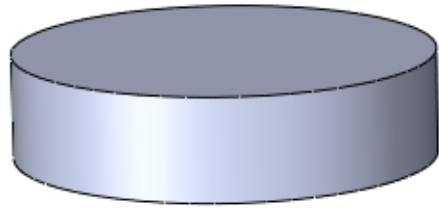

20 MGAL

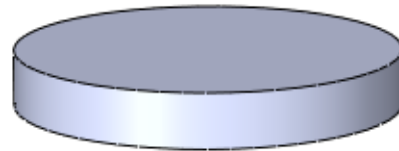

9 MGAL

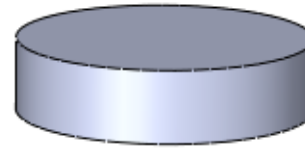

7 MGAL

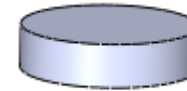

1.5 MGAL

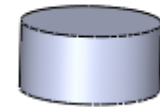

1.5 MGAL



0.2 MGAL

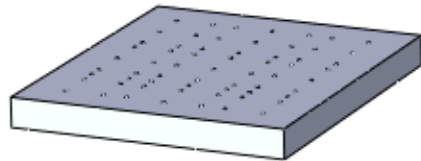

6 MGAL

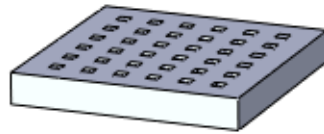

3 MGAL

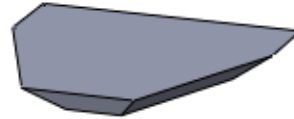

2 MGAL



2 MGAL



0.5 MGAL



1 MGAL



0.5 MGAL

# Simple Installation

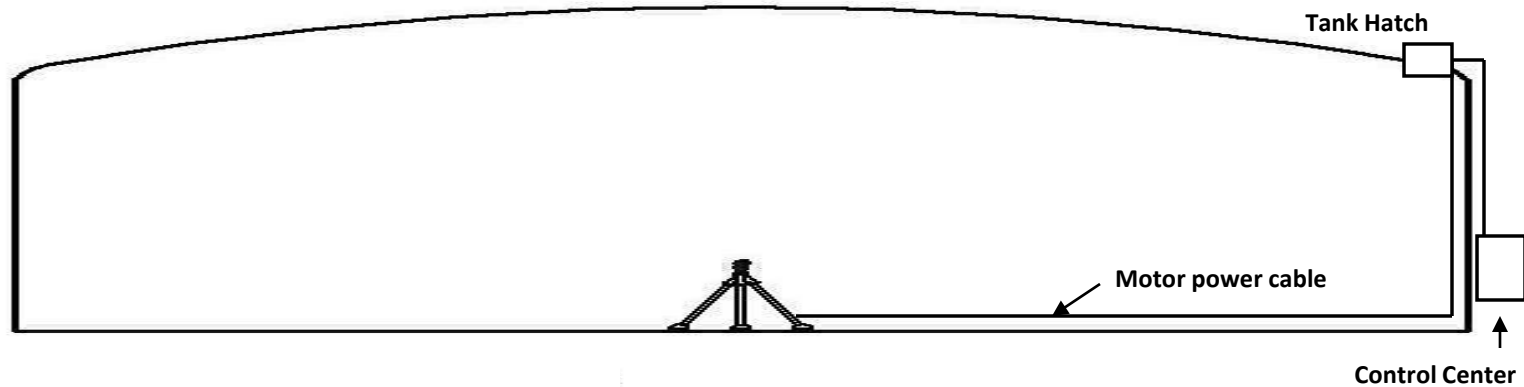

# Biomimicry

Biology + Mimicry

*Copy the high efficiencies found in nature*





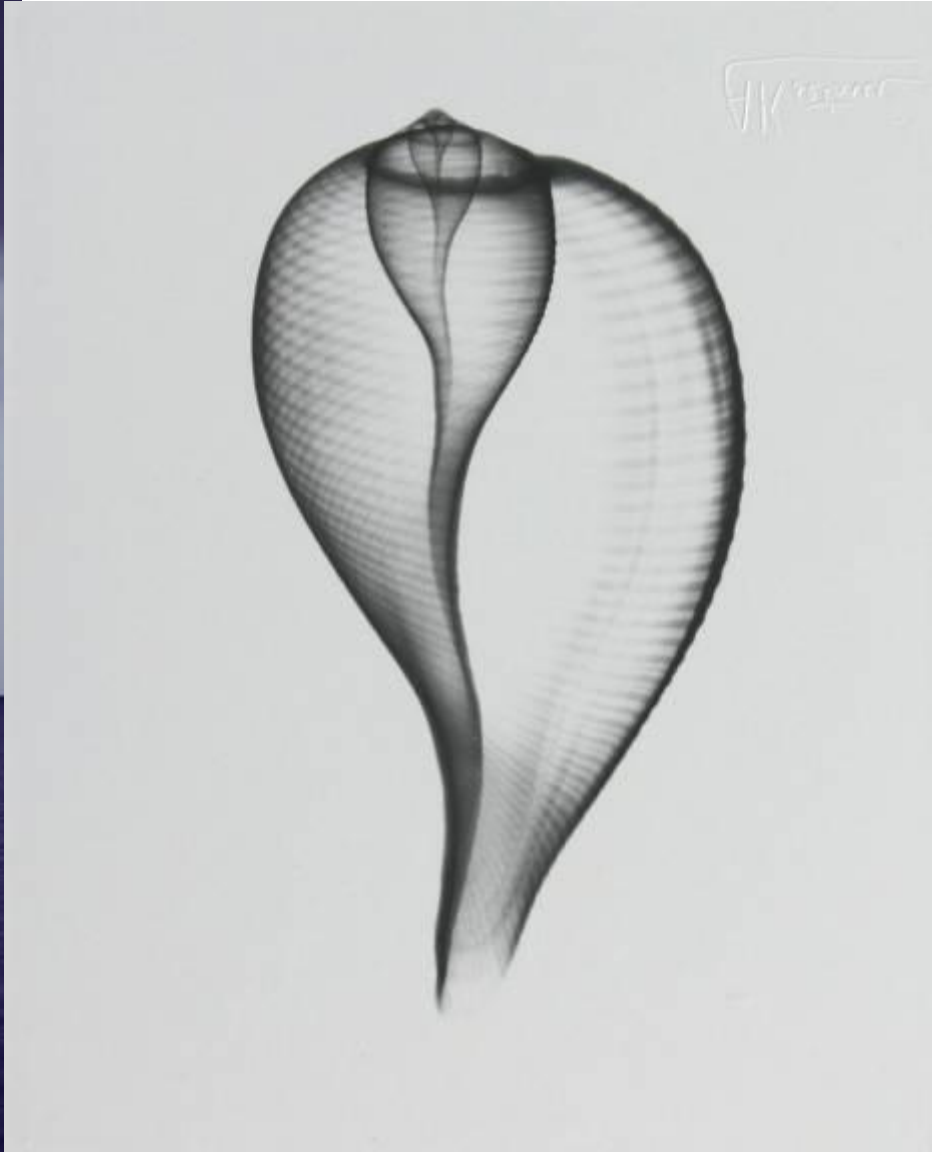



# Biomimetic design of impeller

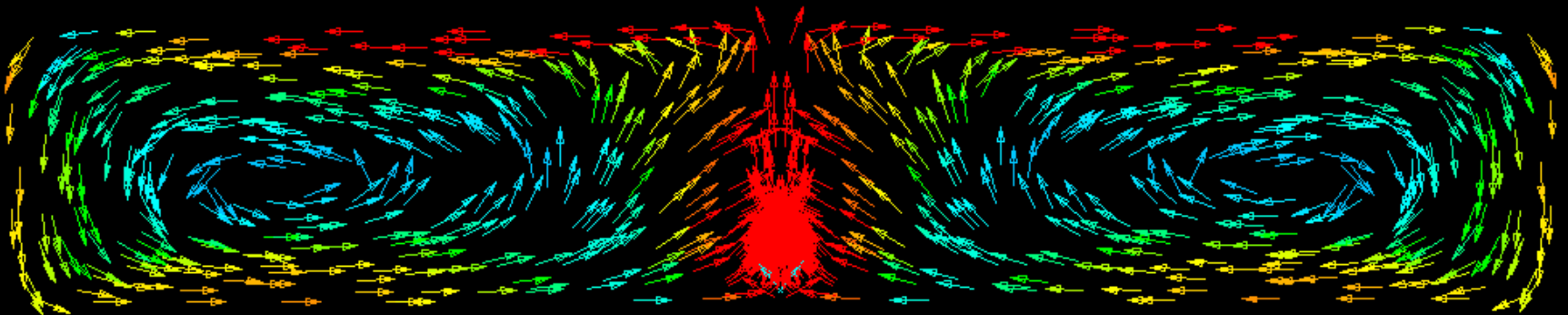
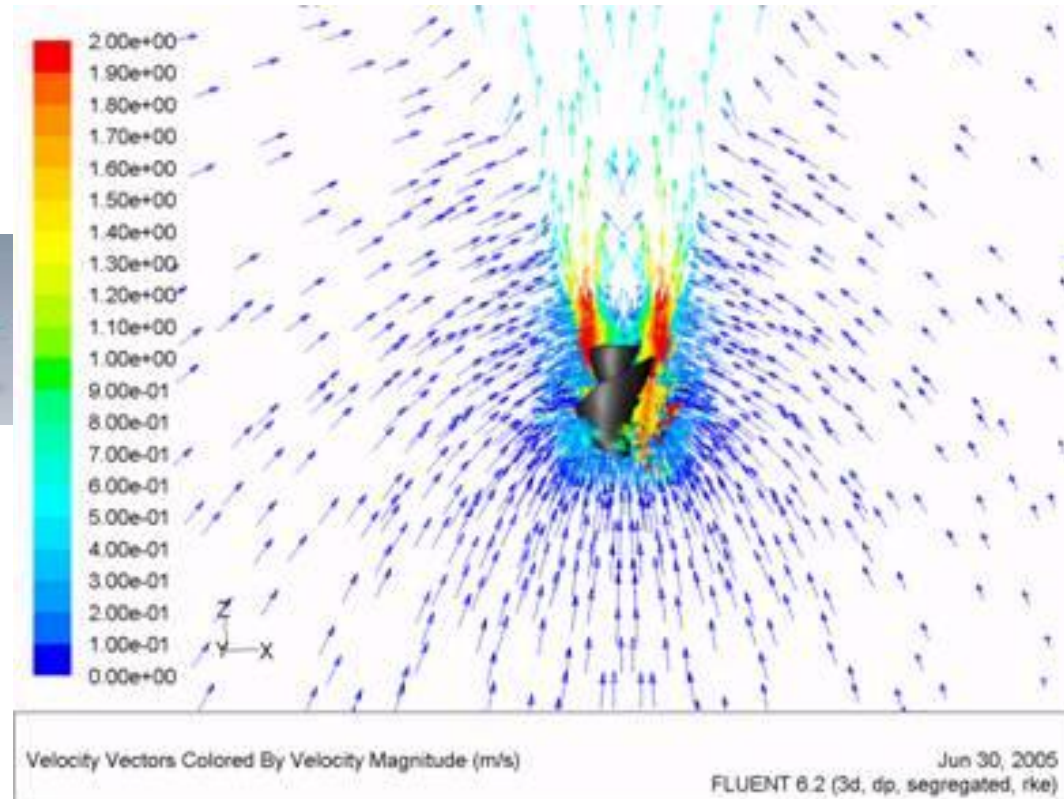
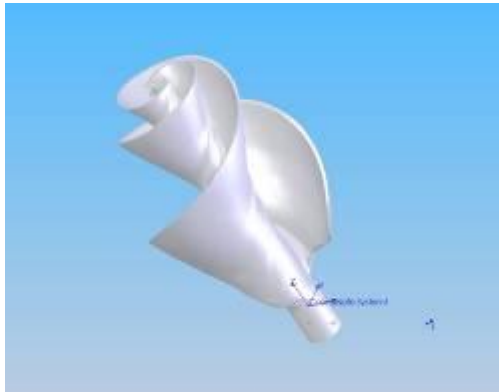
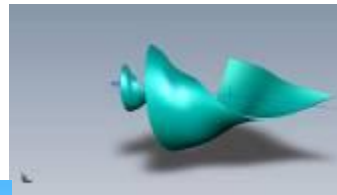

# THM Removal Systems - Customized

